

Copyright

Information in this document is subject to change without notice.

©2010 Dell Inc. All rights reserved.

Reproduction of these materials in any manner whatsoever without the written permission of Dell Inc. is strictly forbidden.

Trademarks used in this text: Dell, the DELL logo, and Dell Toner Management System are trademarks of Dell Inc.; Microsoft, Windows, Windows Vista, and Windows Server are registered trademarks of Microsoft Corporation in the United States and/or other countries; Adobe and Acrobat Reader are either registered trademarks or trademarks of Adobe Systems Incorporated in the United States and/or other countries.

Other trademarks and trade names may be used in this document to refer to the entities claiming the marks and names of their products.

Dell Inc. disclaims any proprietary interest in trademarks and trade names other than its own.

Refer to the '**LICENSE.txt**' file in the provided CD-ROM for the open source license information.

REV. 1.02

Multi-Functional Printer

User's Guide

www.dell.com | support.dell.com









Safety information

These warnings and precautions are included in order to prevent injury to you and others, as well as preventing any potential damage to your machine. Be sure to read and understand all of these instructions before using the machine. Use common sense for operating any electrical appliance and whenever using your machine. Also, follow all warnings and instructions marked on the machine and in the accompanying literature. After reading this section, keep it in a safe place for future reference.

Important safety symbols

This section explains the meanings of all icons and signs in the user's guide. These safety symbols are in order, according to the degree of danger.

Explanation of all icons and signs used in the user's guide:

	Warning	Hazards or unsafe practices that may result in severe personal injury or death.
	Caution	Hazards or unsafe practices that may result in minor personal injury or property damage.
	Do not attempt.	
	Do not disassemble.	
	Do not touch.	
	Unplug the power cord from the wall socket.	
	Make sure the machine is grounded to prevent electric shock.	
	Call the service center for help.	
	Follow directions explicitly.	

Operating environment

Warning



Do not use if the power cord is damaged or if the electrical outlet is not grounded. This could result in electric shock or fire.



Do not bend, or place heavy objects on the power cord. Stepping on or allowing the power cord to be crushed by a heavy object could result in electric shock or fire.



Do not place anything on top of the machine (water, small metal or heavy objects, candles, lit cigarettes, etc.). This could result in electric shock or fire.



Do not remove the plug by pulling on the cord; do not handle the plug with wet hands.

This could result in electric shock or fire.

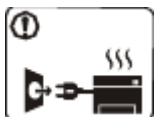

If the machine gets overheated, it releases smoke, makes strange noises, or generates an odd odor, immediately turn off the power switch and unplug the machine. This could result in electric shock or fire.

Caution

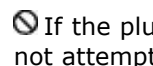

During an electrical storm or for a period of non-operation, remove the power plug from the electrical outlet. This could result in electric shock or fire.

 If the plug does not easily enter the electrical outlet, do not attempt to force it in.

Call an electrician to change the electrical outlet, or this could result in electric shock.

 Be careful, the paper output area is hot. Burns could occur.

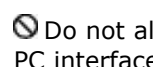
 Do not allow pets to chew on the AC power, telephone or PC interface cords.

ⓘ If the machine has been dropped, or if the cabinet appears damaged, unplug the machine from all interface connections and request assistance from qualified service personnel.

Otherwise, this could result in electric shock or fire.

ⓘ If the machine exhibits a sudden and distinct change in performance, unplug the machine from all interface connections and request assistance from qualified service personnel.

Otherwise, this could result in electric shock or fire.

This could result in electric shock or fire and/or injury to your pet.

ⓘ If the machine does not operate properly after these instructions have been followed, unplug the machine from all interface connections and request assistance from qualified service personnel.

Otherwise, this could result in electric shock or fire.

Operating method

⚠ Caution



Do not forcefully pull the paper out during printing. It can cause damage to the machine.



Be careful not to put your hand between the machine and paper tray. You may get injured.

⊘ Do not block or push objects into the ventilation opening.

This could result in elevated component temperatures which can cause damage or fire.

⊘ Use care to avoid paper cuts when replacing paper or removing jammed paper. You may get hurt.



When printing large quantities, the bottom part of the paper output area may get hot. Do not allow children to touch.

Children may be burned.



When removing jammed paper, do not use tweezers or sharp metal objects.

It can cause damage to the machine.

⊘ Do not allow too many papers to stack up in the paper output tray.

It could cause damage to the machine.

⊘ This machine's power interception device is the power cord. To switch off the power supply, remove the power cord from the electrical outlet.

Installation / Moving

⚠ Warning



Do not place the machine in an area with dust, humidity or water leaks. This could result in electric shock or fire.

⚠ Caution



When moving the machine, turn the power off and disconnect all cords; then lift the machine with at least two people are required to lift printer.

The machine could fall, causing human injury or machine damage.

ⓘ Do not place the machine on an unstable surface.

The machine could fall, causing human injury or machine damage.

⊘ The machine should be connected to the power level which is specified on the label.

If you are unsure and want to check the power level you are using, contact the electrical utility company.

ⓘ Use only No.26 AWG^[a] or larger, telephone line cord, if necessary.

⊘ Do not put a cover over the machine or place it in an airtight location, such as a closet. If the machine is not well-ventilated, this could result in fire.

ⓘ Make sure you plug the power cord into a grounded electrical outlet.

Otherwise, this could result in electric shock or fire.

⊘ Do not overload wall outlets and extension cords.

This can diminish performance, and could result in electric shock or fire.

ⓘ Use the power cord supplied with your machine for safe operation. If you are using a cord which is longer than 2 meters (79") with a 140V machine, then the gauge should be

Otherwise, it can cause damage to the machine.

16 AWG or larger.

Otherwise, it can cause damage to the machine, and could result in electric shock or fire.

[a] AWG: American Wire Gauge

Maintenance / Checking

⚠ Caution



Unplug this product from the wall outlet before cleaning the inside of the machine. Do not clean the machine with benzene, paint thinner or alcohol; do not spray water directly into the machine.

This could result in electric shock or fire.



When you are working inside the machine replacing supplies or cleaning the inside, do not operate the machine. You may get injured.



Keep cleaning supplies away from children. Children may get hurt.



Do not disassemble, repair or rebuild the machine by yourself. It can cause damage to the machine. Call a certified technician when the machine needs repair.

ⓘ Keep the power cable and the contact surface of the plug clean from dust or water.

This could result in electric shock or fire.

ⓘ To clean and operate the machine, follow the user's guide provided with the machine. Otherwise, it can cause damage to the machine.

⊗ Do not remove any covers or guards that are fastened with screws. The machine should only be repaired by Dell service technician.

Supply usage

⚠ Caution



Do not disassemble the toner cartridge. Toner dust can be hazardous.



Do not burn any of the supplies such as toner cartridge or fuser unit. It can cause an explosion or fire.



When storing supplies such as toner cartridges, keep them away from children.

Toner dust can be hazardous.

⊗ Using recycled supplies, such as toner, can cause damage to the machine.

In case of damage due to the use of recycled supplies, a service fee will be charged.

ⓘ When changing the toner cartridge or removing jammed paper, be careful not to let toner dust touch your body or clothes.

Toner dust can be dangerous to humans.

Introduction

This chapter gives you an overview of your machine:

This chapter includes:

- [Machine overview](#)
- [Control panel overview](#)
- [Understanding the Status LED](#)
- [Introducing the useful buttons](#)
- [Turning on the machine](#)

Machine overview

Front view

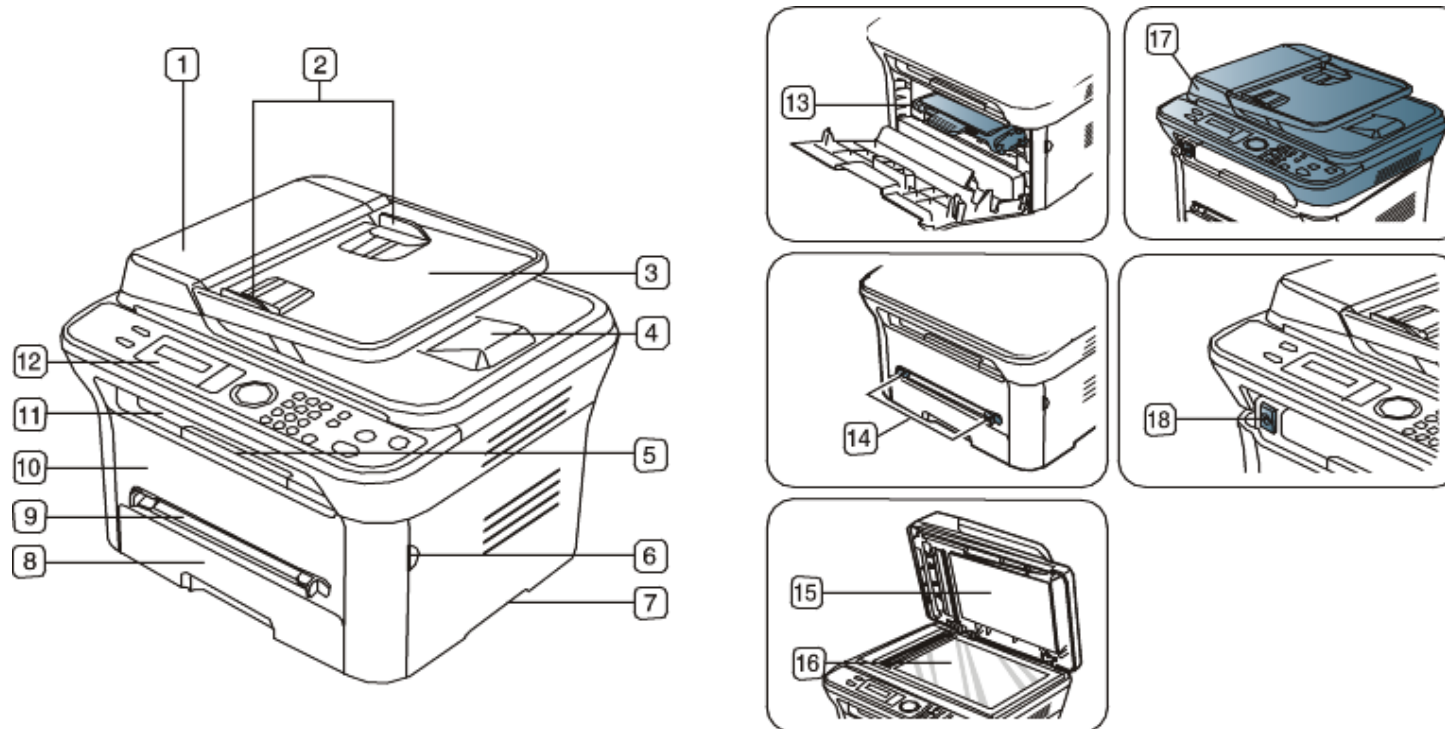

This illustration may differ from your machine depending on its model.

1	Document feeder cover	6	Front door handle	11	Document output tray	16	Scanner glass
2	Document feeder width guides	7	Handle	12	Control panel	17	Scan unit

3	Document feeder input tray	8	Tray 1	13	Toner cartridge	18	Scan unit close button ^[a]
4	Document feeder output tray	9	Manual tray	14	Manual tray paper width guides		
5	Output support	10	Front door	15	Scanner lid		

^[a] This button is used when you close the scan unit.

Rear view

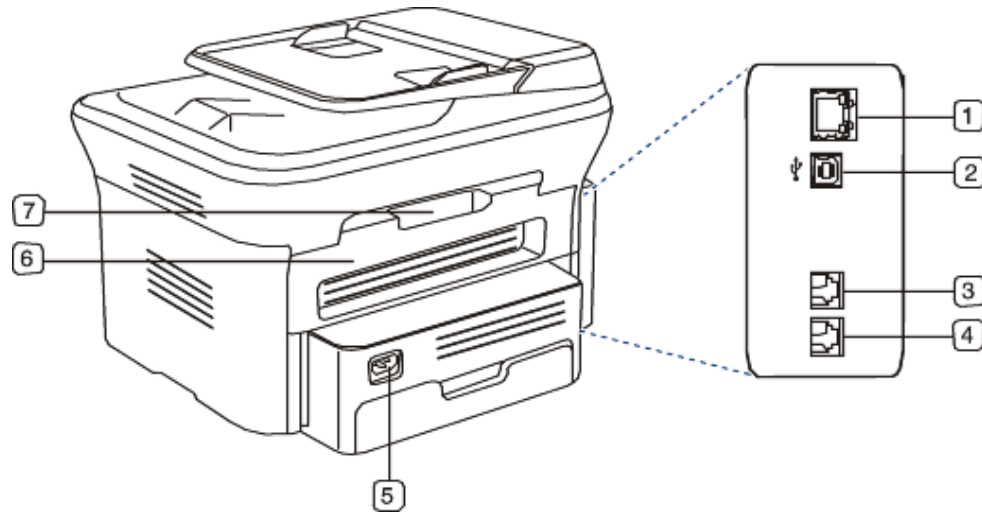







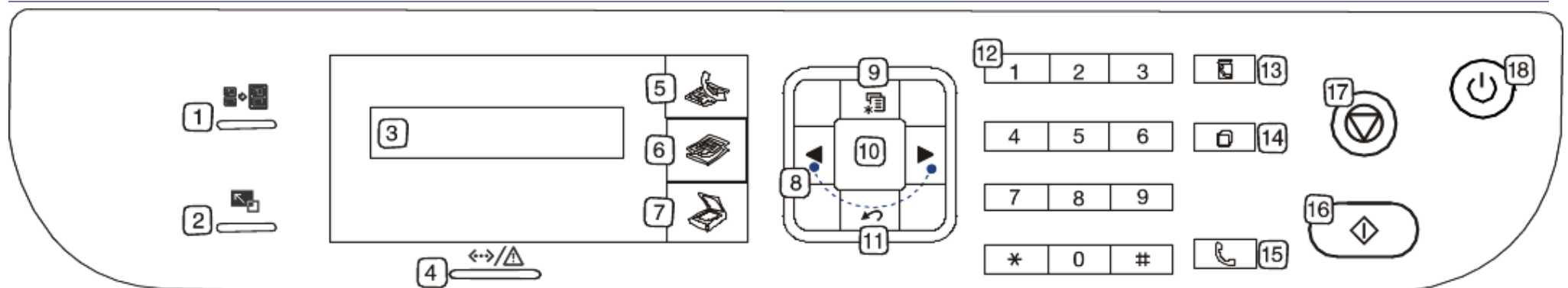





This illustration may differ from your machine depending on its model.

1	Network port	5	Power receptacle
2	USB port	6	Rear door
3	Telephone line socket	7	Rear door handle
4	Extension telephone socket (EXT)		

Control panel overview



2	Reduce/Enlarge ()	Makes a copy smaller or larger than the original.
3	Display	Shows the current status and prompts during an operation.
4	Status ()	Shows the status of your machine (See Understanding the Status LED).
5	Fax ()	Activates fax mode.
6	Copy ()	Activates copy mode.
7	Scan ()	Activates scan mode.
8	Arrow	Scroll through the options available in the selected menu, and increase or decrease values.
9	Menu ()	Enters Menu mode and scrolls through the available menus (See Machine status and advanced feature).
10	OK	Confirms the selection on the screen.
11	Back	Sends you back to the upper menu level.
12	Numeric keypad	Dials fax number, and enters the number value for document copies or other options.
13	Address Book ()	Allows you to store frequently used fax numbers or search for stored fax numbers.
14	Redial/Pause ()	In standby mode, redials the last number. Also in edit mode, inserts a pause into a fax number.
15	On Hook Dial ()	Enables you to dial a number with the receiver on the hook.
16	Start ()	Starts a job.
17	Stop/Clear ()	Stops an operation at any time. The pop-up window appears on the screen showing the current job that the user can stop or resume.
18	Power ()	You can turn the power on and off (See Power button).

Understanding the Status LED

The color of the status LED indicates the machine's current status.

Status		Description
Off		<ul style="list-style-type: none"> The machine is off-line. The machine is in power saver mode. When data is received, or any button is pressed, it switches to on-line automatically.
Green	Blinking	<ul style="list-style-type: none"> When the backlight slowly blinks, the machine is receiving data from the computer. When the backlight blinks rapidly, the machine is printing data.
	On	The machine is on-line and can be used.
Red	Blinking	<ul style="list-style-type: none"> A minor error has occurred and the machine is waiting for the error to be cleared. Check the display message. When the problem is cleared, the machine resumes. Small amount of toner is left in the cartridge. The estimated cartridge life^[a] of toner is close. Prepare a new cartridge for replacement. You may temporarily increase the printing quality by redistributing the toner. (See Redistributing toner.)
	On	<ul style="list-style-type: none"> A toner cartridge has almost reached the end of its estimated cartridge life^[a]. It is recommended to replace the toner cartridge (See Replacing the toner cartridge). A paper jam has occurred (See Clearing paper jams). The cover is opened. Close the cover.

There is no paper in the tray. Load paper in the tray.

- The machine has stopped due to a major error. Check the display message (See [Understanding display messages](#)).

[a] Estimated cartridge life means the expected or estimated toner cartridge life, which indicates the average capacity of print-outs and is designed pursuant to ISO/IEC 19752. The number of pages may be affected by operating environment, printing interval, media type, and media size. Some amount of toner may remain in the cartridge even when **End of life Replace new cart** appears and the printer stops printing.

- ⚠ Dell does not recommend using a non-genuine Dell toner cartridge such as one that is refilled or remanufactured. Dell cannot guarantee a non-genuine Dell toner cartridge's quality. Service or repair required as a result of using non-genuine Dell toner cartridges will not be covered under the machine warranty.
- 🔧 Check the message on the display. Follow the instructions in the message or refer to troubleshooting part (See [Understanding display messages](#)). If the problem persists, call for service.
- 🔧 All printing errors will appear in the Printer Status Monitor program window. If the problem persists, call for service.

Introducing the useful buttons

Menu button



When you want to know the machine status and set your machine to use an advanced feature, click the **Menu** button (See [Machine status and advanced feature](#)).

Power button



When you want to turn the power off, press this button until **Power Down** appear. Choose **Yes**, to turn the power off. This button can also be used to turn the machine on.

Status	Description
Off	<ul style="list-style-type: none">• The machine is in ready mode.• The machine's power is off.
On	The machine is in power save mode.

Turning on the machine

Plug in the power cord, the machine will be turned on.

- 🔧 If you want to turn the power off, press the **Power** (🔌) button until **Power Down** appear on the display.

About this user's guide

This user's guide provides information about how to use the machine.



- Read the safety information before using the machine.
- If you have a problem using the machine, refer to the troubleshooting chapter (See [Troubleshooting](#)).
- Terms used in this user's guide are explained in the glossary chapter (See [Glossary](#)).
- Illustrations in this user's guide may differ from your machine depending on its options or models.
- The procedures in this user's guide are mainly based on Windows XP.

Convention

Some terms in this guide are used interchangeably, as below:



- Document is synonymous with original.
- Paper is synonymous with media, or print media.
- Machine refers to printer or MFP.

The following table offers the conventions of this guide:

Convention	Description	Example
Bold	For texts on the display or button names on the machine.	Start
Note	Provides additional information or detailed specification of the machine function and feature.	 The date format may differ from country to country.
Caution	Gives users information to protect the machine from possible mechanical damage or malfunction.	 Do not touch the green underside of the toner cartridge.
Footnote	Provides additional more detailed information on certain words or a phrase.	a. pages per minute
("Cross-reference")	Guides users to a reference page for the additional detailed information.	(See Finding more information).

Finding more information

You can find information for setting up and using your machine from the following resources: either as a print-out or on screen.

Material name	Description
Quick Install Guide 	This guide provides basic information on setting up your machine.
User's Guide 	This guide provides you with step-by-step instructions for using your machine's full features, and contains information for maintaining your machine, troubleshooting, and replacing supplies.
Machine Driver Help	This help provides you with help information on printer driver and instructions for setting up the options for printing (See Using help).
Dell website	If you have Internet access, you can get help, support, machine drivers, manuals, and order information from the Dell website, www.dell.com or support.dell.com .

Features of your new product

Your new machine is equipped with a number of special features that improve the quality of the documents you print.

Special Features

Print with excellent quality and speed



- You can print with a resolution of up to 1200 x 1200 dpi effective output.
- Your machine prints A4-sized paper at up to 22 ppm and letter-sized paper at up to 23 ppm.

Handle many different types of printable material

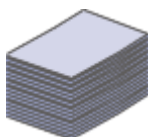

- Manual tray supports plain paper in various sizes, letterhead, envelopes, labels, custom-sized media, postcards, and heavy paper.
- The 250-sheet tray supports plain paper.

Create professional documents



- Print Watermarks. You can customize your documents with words, such as "Confidential" (See [Using watermarks](#)).
- Print Posters. The text and pictures of each page of your document are magnified and printed across the sheet of paper and can then be taped together to form a poster (See [Printing posters](#)).
- You can use preprinted forms with plain paper (See [Using overlay](#)).

Save time and money



- To save paper, you can print multiple pages on one single sheet of paper (See [Printing multiple pages on one sheet of paper](#)).
- This machine automatically conserves electricity by substantially reducing power consumption when not in use.
- To save paper, you can print on both sides of the paper (manual) (See [Printing on both sides of paper \(Manual\)](#)).

Print in various environments



- You can print with various operating system such as Windows, Linux, and Macintosh systems (See [System requirements](#)).
- Your machine is equipped with a USB interface and a network interface.

Copy originals in several formats



- Your machine can copy multiple image copies from the original document on a single page (See [2-up or 4-up copying \(N-up\)](#)).
- The print quality and image size may be adjusted and enhanced at the same time.

Scan the originals and send it right away



- Scan in color and use the precise compressions of JPEG, TIFF, and PDF formats.
- Quickly scan and send files to multiple destinations using Networks scanning (See [For network connected machine](#)).

Set a specific time to transmit a Fax



- You can specify a certain time to transmit the fax and also send the fax to several stored destinations.
- After the transmission, the machine may print out the fax reports according to the setting.

IPv6



This machine supports IPv6.

Features by Model

The machine is designed to support all of your document needs from printing and copying to more advanced networking solutions for your business.

Some features and optional goods may not be available depending on models or countries.

Features by model include:

FEATURES	Dell 1135n
Print	?
Duplex (2-sided) printing (manual)	?
Copy	?
FAX	?
Network PC fax	?
Fax to PC (Dell Scan and Fax Manager)	?
On hook dial	?
USB 2.0	?
Network Interface Ethernet 10/100 Base TX wired LAN	?
IPv6	?
Embedded Web Service	?
Document Feeder	?

(? : Included)

Getting started

This chapter gives you step-by-step instructions for setting up the USB connected machine and software.

This chapter includes:

- [Setting up the hardware](#)
- [Supplied software](#)
- [System requirements](#)
- [Installing USB connected machine's driver](#)
- [Sharing your machine locally](#)

 Supported optional devices and features may differ according to your model. Please check your model name. (See [Features by Model](#)).

Setting up the hardware

This section shows the steps to set up the hardware, as explained in the Quick Install Guide. Make sure you read the Quick Install Guide first and follow the steps below:

1. Select a stable location.

Select a level, stable place with adequate space for air circulation. Allow extra space to open covers and trays.

The area should be well ventilated and away from direct sunlight or sources of heat, cold, and humidity. Do not set the machine close to the edge of your desk or table.

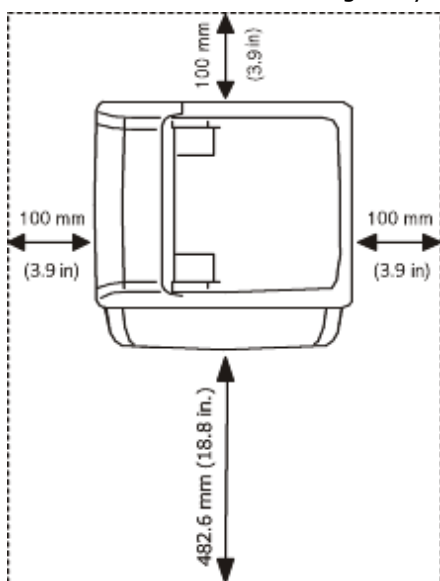

Printing is suitable for altitudes under 1,000 m (3,281 ft.). Refer to the altitude setting to optimize your printing (See [Altitude adjustment](#)).

Place the machine on a flat, stable surface so that there is no incline greater than 2 mm (0.08 inch). Otherwise, printing quality may be affected.

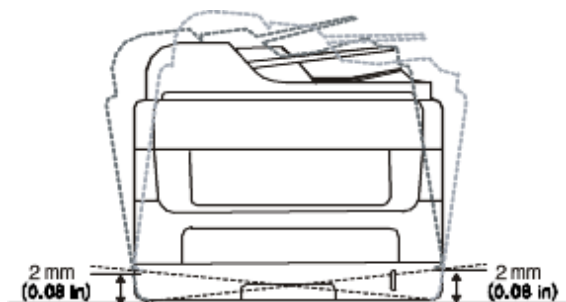

2. Unpack the machine and check all the enclosed items.
3. Remove all tape.
4. Install the toner cartridge.

5. Load paper (See [Loading paper in the tray](#)).
6. Make sure that all cables are connected to the machine.
7. Turn the machine on.

 This equipment will be inoperable when mains power fails.

Supplied software

After you have set up your machine and connected it to your computer, you must install the printer software using the supplied CD. The software CD provides you with the following software.

OS	Contents
Windows	<ul style="list-style-type: none"> • Printer driver: Use this driver to take full advantage of your machine's features. • Scanner driver: TWAIN and Windows Image Acquisition (WIA) drivers are available for scanning documents on your machine. • Printer Settings Utility: This program allows you to set up printer's other options from your computer desktop. • Printer Status Monitor: This program allows you to monitor the machine's status and alerts you when an error occurs during printing. • SmarThru^[a]: This program is the accompanying Windows-based software for your multifunctional machine. • Dell Scan and Fax Manager: You can find out about Dell Scan and Fax Manager program information and installed scan driver's condition. • Dell 1135n Laser MFP Toner Reorder: The Dell 1133 Laser MFP Toner Reorder window also displays the level of toner remaining and allows you to order replacement toner cartridge. • Firmware Update Utility: This program helps you to update printer's firmware. • SetIP: Use this program to set your machine's TCP/IP addresses.
Macintosh	<ul style="list-style-type: none"> • Printer driver: Use this driver to take full advantage of your machine's features. • Scanner driver: TWAIN driver is available for scanning documents on your machine. • SetIP: Use this program to set your machine's TCP/IP addresses.
Linux	<ul style="list-style-type: none"> • Unified Linux Driver: Use this driver to take full advantage of your machine's features. • SANE: Use this driver to scan documents. • SetIP: Use this program to set your machine's TCP/IP addresses.

[a] Allows you to edit a scanned image in various ways using a powerful image editor and to send the image by email. You can also open another image editor program, such as Adobe Photoshop, from SmarThru. For details, refer to the on screen help supplied on the SmarThru program (See [Smarthru](#)).

System requirements

Before you begin, ensure that your system meets the following requirements:

Microsoft® Windows®

Your machine supports the following Windows operating systems.

OPERATING SYSTEM	Requirement (recommended)		
	CPU	RAM	free HDD space
Windows® 2000	Intel® Pentium® II 400 MHz (Pentium III 933 MHz)	64 MB (128 MB)	600 MB
Windows® XP	Intel® Pentium® III 933 MHz (Pentium IV 1 GHz)	128 MB (256 MB)	1.5 GB
Windows Server® 2003	Intel® Pentium® III 933 MHz (Pentium IV 1 GHz)	128 MB (512 MB)	1.25 GB to 2 GB
Windows Server® 2008	Intel® Pentium® IV 1 GHz (Pentium IV 2 GHz)	512 MB (2048 MB)	10 GB
Windows Vista®	Intel® Pentium® IV 3 GHz	512 MB (1024 MB)	15 GB

Windows® 7	Intel® Pentium® IV 1 GHz 32-bit or 64-bit processor or higher	1 GB (2 GB)	16 GB
	<ul style="list-style-type: none"> • Support for Direct® 9 graphics with 128 MB memory (to enable the Aero theme). • DVD-R/W Drive 		
Windows Server® 2008 R2	Intel® Pentium® IV 1 GHz (x86) or 1.4 GHz (x64) processors (2 GHz or faster)	512 MB (2048 MB)	10 GB

- Internet Explorer® 5.0 or higher is the minimum requirement for all Windows operating systems.
- Administrator rights are required to install the software.
- **Windows Terminal Services** is compatible with this machine.

Macintosh

OPERATING SYSTEM	Requirements (recommended)		
	CPU	RAM	free HDD space
Mac OS X 10.3 ~ 10.4	<ul style="list-style-type: none"> • Intel® Processors • PowerPC G4/ G5 	<ul style="list-style-type: none"> • 128 MB for a PowerPC based Mac (512 MB) • 512 MB for a Intel-based Mac (1 GB) 	1 GB
Mac OS X 10.5	<ul style="list-style-type: none"> • Intel® Processors • 867 MHz or faster Power PC G4/ G5 	512 MB (1 GB)	1 GB
Mac OS X 10.6	<ul style="list-style-type: none"> • Intel® Processors 	1 GB (2 GB)	1 GB

Linux

Item	Requirement (recommended)
Operating system	RedHat® Enterprise Linux WS 4, 5 (32/64 bit) Fedora Core 2~10 (32/64 bit) SuSE Linux 9.1 (32 bit) OpenSUSE® 9.2, 9.3, 10.0, 10.1, 10.2, 10.3, 11.0, 11.1 (32/64 bit) Mandrake 10.0, 10.1 (32/64 bit) Mandriva 2005, 2006, 2007, 2008, 2009 (32/64 bit) Ubuntu 6.06, 6.10, 7.04, 7.10, 8.04, 8.10 (32/64 bit) SuSE Linux Enterprise Desktop 9, 10 (32/64 bit) Debian 3.1, 4.0, 5.0 (32/64 bit)
CPU	Pentium® IV 2.4 GHz (Intel Core™2)
RAM	512 MB (1024 MB)
Free HDD space	1 GB (2 GB)

- It is necessary to claim swap partition of 300 MB or larger for working with large scanned images.
- The Linux scanner driver supports the optical resolution at maximum.

Installing USB connected machine's driver

A locally connected machine is a machine directly attached to your computer using the USB cable.)

- Only use an USB cable shorter than 3 m (118 in.).

Windows

You can install the machine software using the typical or custom method.

The following steps below are recommended for most users who use a machine directly connected to your computer. All components necessary for machine operations will be installed.

1. Make sure that the machine is connected to the computer and powered on.

- If the "Found New Hardware Wizard" window appears during the installation procedure, click **Cancel** in close the window.

2. Insert the supplied software CD into your CD/DVD drive.

The software CD should automatically run and an installation window should appear.

- If the installation window does not appear, click **Start** and then **Run**. Type X:\Setup.exe, replacing "X" with the letter which represents your CD/DVD drive. Click **OK**.
- If you use Windows Vista, Windows 7, or Windows 2008 Server R2 click **Start > All programs > Accessories > Run**. Type X:\Setup.exe replacing "X" with the letter which represents your CD/DVD drive and click **OK**.
- If the **AutoPlay** window appears in Windows Vista, Windows 7, or Windows 2008 Server R2, click **Run Setup.exe** in **Install or run program** field, and click **Continue** or **Yes** in the **User Account Control** windows.

3. Click **Next**.

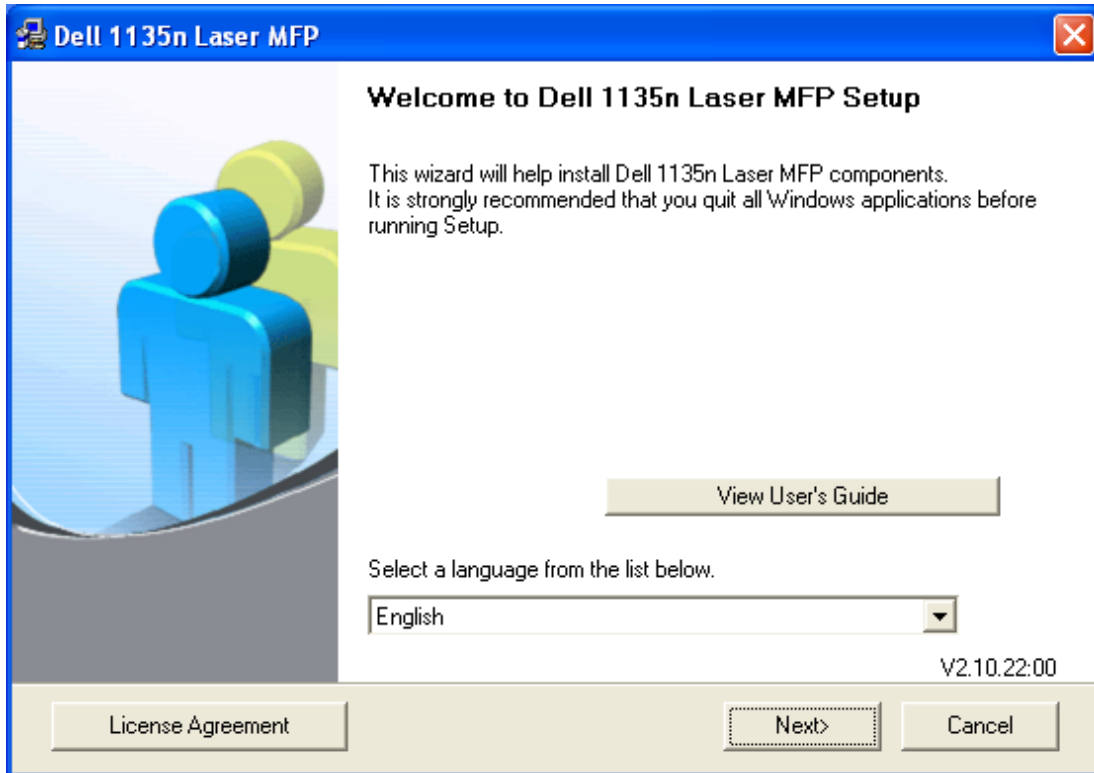

If necessary, select a language from the drop-down list.

4. Select **Typical installation for a local printer**. Then, click **Next**.

- ☞ The **Custom** allows you to select the machine's connection and choose individual component to install. Follow the on-screen instructions.

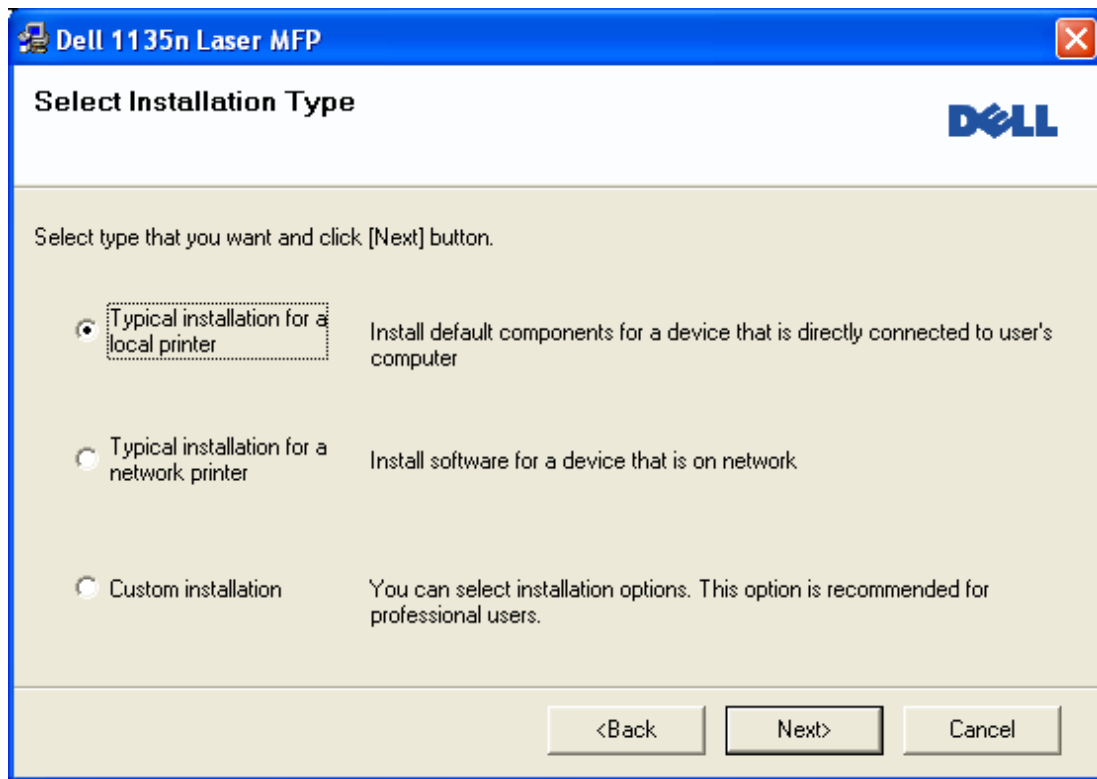

✎ If your machine is not connected to the computer, the following window will appear.

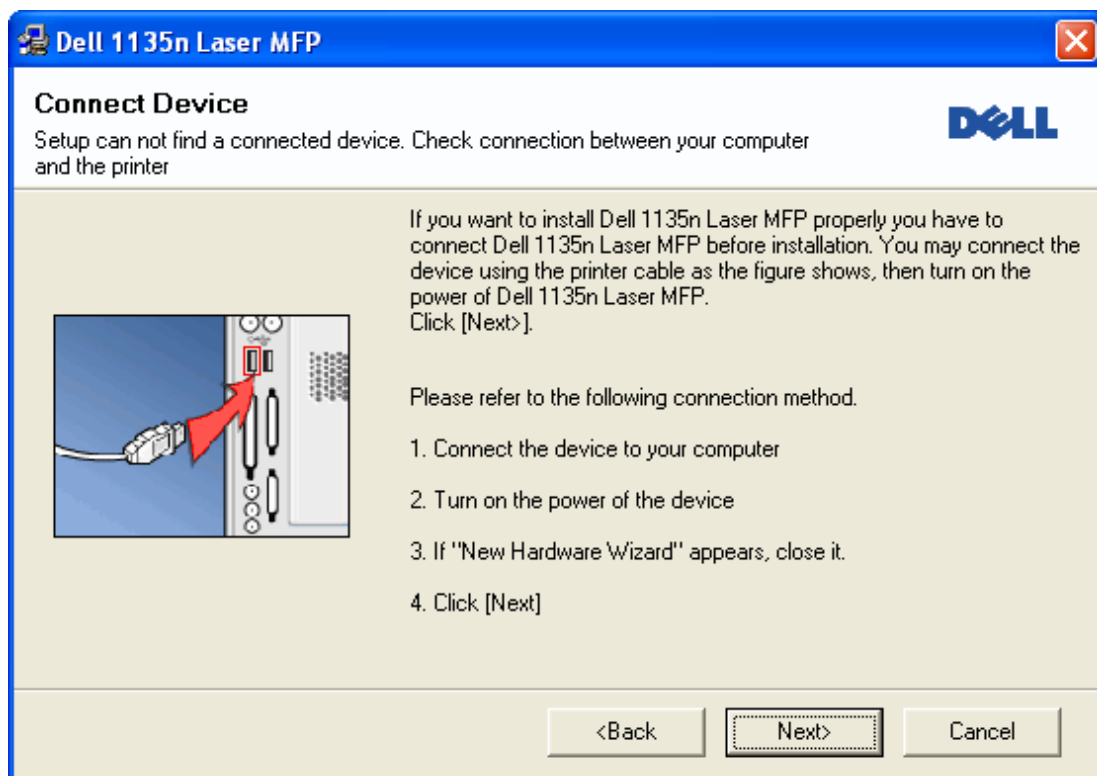

- After connecting the machine, click **Next**.
- If you don't want to connect the printer at this time, click **Next**, and **No** on the following screen. The installation starts and a test page will not print at the end of the installation.
- The installation window in this user guide may differ depending on the machine and interface in use.

5. After the installation is finished, a window asking you to print a test page appears. If you choose to print a test page, select the checkbox and click **Next**. Otherwise, just click **Next** and skip to step 7.

6. If the test page prints out correctly, click **Yes**.
If not, click **No** to reprint it.

7. Click **Finish**.

✎ If the printer driver does not work properly, follow the steps below to repair or reinstall the driver.

1. Make sure that the machine is connected to your machine and powered on.
2. From the **Start** menu, select **Programs** or **All Programs** > **Dell** > **Dell Printers** > **your printer**

driver name > Maintenance.

3. Select the option as you wish, follow the instruction on the window.

Macintosh

The software CD provides the driver files that allow you to use the CUPS driver for printing on a Macintosh computer.

Also, it provides you with the TWAIN driver for scanning on a Macintosh computer.

1. Make sure that the machine is connected to your computer and powered on.
2. Insert the supplied software CD into your CD/DVD drive.
3. Double-click the CD-ROM icon that appears on your Macintosh desktop.
4. Double-click the **MAC_Installer** folder.
5. Double-click the **Installer OS X** icon.
6. Enter the password and click **OK**.
7. The Dell Installer window opens. Click **Continue**.
8. Read the license agreement and click **Continue**.
9. Click **Agree** to agree to the license agreement.
10. Select **Easy Install** and click **Install**. **Easy Install** is recommended for most users. All components necessary for machine operations will be installed.
If you select **Custom Install**, you can choose individual components to install.
11. When the message which warns that all applications will close on your computer appears, click **Continue**.
12. After the installation is finished, click **Quit**.
 If you have installed scanner driver, click **Restart**.
13. Open the **Applications** folder > **Utilities** > **Print Setup Utility**.
 - For Mac OS X 10.5 ~ 10.6, open the **Applications** folder > **System Preferences** and click **Print & Fax**.
14. Click **Add** on the **Printer List**.
 - For Mac OS X 10.5 ~ 10.6, press the "+" icon; a display window will pop up.
15. For Mac OS X 10.3, select the **USB** tab.
 - For Mac OS X 10.4, click **Default Browser** and find the USB connection.
 - For Mac OS X 10.5 ~ 10.6, click **Default** and find the USB connection.
16. For Mac OS X 10.3, if Auto Select does not work properly, select **Dell** in **Printer Model** and your machine name in **Model Name**.
 - For Mac OS X 10.4, if Auto Select does not work properly, select **Dell** in **Print Using** and your machine name in **Model**.
 - For Mac OS X 10.5 ~ 10.6, if Auto Select does not work properly, select **Select a driver to use...** and your machine name in **Print Using**.

Your machine appears on the **Printer List**, and is set as the default machine.

17. Click **Add**.

 If the printer driver does not work properly, uninstall the driver and reinstall it. Follow steps below to uninstall the driver for Macintosh.

1. Make sure that the machine is connected to your computer and powered on.
2. Insert the supplied software CD into your CD/DVD drive.
3. Double-click CD-ROM icon that appears on your Macintosh desktop.
4. Double-click the **MAC_Installer** folder.
5. Double-click the **Installer OS X** icon.
6. Enter the password and click **OK**.
7. The Dell Installer window opens. Click **Continue**.
8. Select **Uninstall** and click **Uninstall**.
9. When the message which warns that all applications will close on your computer appears, click **Continue**.
10. When the uninstall is done, click **Quit**.

Linux

Follow the steps below to install the driver for Linux. While installing the driver, the Unified Linux Driver package will automatically be installed as well.

 The supplied software CD provides you with the Unified Linux Driver package for using your machine with a

Linux computer easily in UI based management tool.

1. Make sure that the machine is connected to your computer and powered on.
2. When the **Administrator Login** window appears, type in root in the **Login** field and enter the system password.
 - ✍ You must log in as a super user (root) to install the machine software. If you are not a super user, ask your system administrator.
3. Insert the supplied software CD into your CD/DVD drive.

The software CD will run automatically.

If the software CD does not run automatically, click the  icon at the bottom of the desktop. When the Terminal screen appears, type in the following:

If the software CD is secondary master and the location to mount is /mnt/cdrom,

```
[root@localhost root]#mount -t iso9660 /dev/hdc /mnt/cdrom
```

```
[root@localhost root]#cd /mnt/cdrom/Linux
```

```
[root@localhost Linux]#./install.sh
```

If you still failed to run the software CD type the followings in sequence:

```
[root@localhost root]#umount /dev/hdc
```

```
[root@localhost root]#mount -t iso9660 /dev/hdc /mnt/cdrom
```

- ✍ The installation program runs automatically if you have an autorun software package installed and configured.

4. When the welcome screen appears, click **Next**.

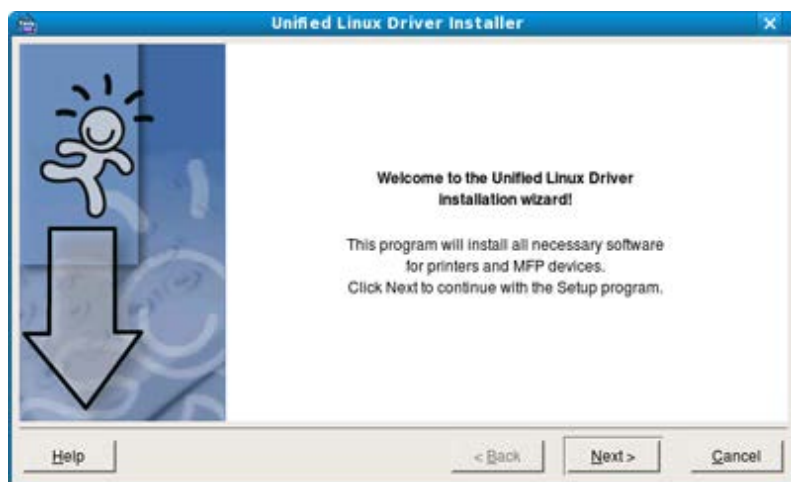

5. When the installation is complete, click **Finish**.

The installation program has added the Unified Driver Configurator desktop icon and the Unified Driver group to the system menu for your convenience. If you have any difficulties, consult the on screen help that is available through your system menu or can otherwise be called from the driver package Windows applications, such as **Unified Driver Configurator** or **Image Manager**.

- ✍ Installing the driver in the text mode:
 - If you do not use the graphical interface or have been unable to install the driver, you have to use the driver in the text mode.
 - Follow the steps 1 to 3, then type [root@localhost Linux]# ./install.sh. Follow the instructions on the terminal screen. The installation is completed.
 - When you want to uninstall the driver, follow the installation instructions above, but type [root@localhost Linux]# ./uninstall.sh on the terminal screen.

- ✍ If the printer driver does not work properly, uninstall the driver and reinstall it. Follow the steps below steps to uninstall the driver for Linux.

1. Make sure that the machine is connected to your computer and powered on.
2. When the **Administrator Login** window appears, type in "root" in the **Login** field and enter the system password.

You must log in as a super user (root) to uninstall the printer driver. If you are not a super user, ask your system administrator.
3. Insert the supplied software CD into your CD/DVD drive.

The software CD will run automatically.

If the software CD does not run automatically, click the  icon at the bottom of the desktop. When the Terminal screen appears, type in:

If the software CD is secondary master and the location to mount is /mnt/cdrom,

```
[root@localhost root]#mount -t iso9660 /dev/hdc /mnt/cdrom
```

```
[root@localhost root]#cd /mnt/cdrom/Linux
```

```
[root@localhost Linux]#./uninstall.sh
```

The installation program runs automatically if you have an autorun software package installed and configured.

4. Click **Uninstall**.
5. Click **Next**.
6. Click **Finish**.

Sharing your machine locally

Follow the steps below to set up the computers to share your machine locally.

If the host computer is directly connected to the machine with a USB cable and is also connected to the local network environment, the client computers connected to the local network can use the shared machine through the host computer to print.

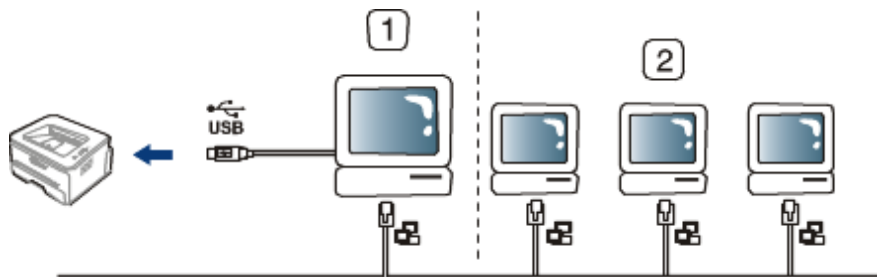

1	Host computer	A computer which is directly connected to the machine by USB cable.
2	Client computers	Computers which use the machine shared through the host computer.

Windows

Setting up a host computer

1. Install your printer driver (See [Installing USB connected machine's driver](#)).
2. Click the Windows **Start** menu.
3. For Windows 2000, select **Settings > Printers**.
 - For Windows XP/2003, select **Printers and Faxes**.
 - For Windows 2008/Vista, select **Control Panel > Hardware and Sound > Printers**.
 - For Windows 7, select **Control Panel > Hardware and Sound > Devices and Printers**.
 - For Windows Server 2008 R2, select **Control Panel > Hardware > Devices and Printers**.
4. Right click your printer icon.
5. For Windows XP/2003/2008/Vista, select/click **Properties**.
For Windows 7 and Windows Server 2008 R2, from context menus, select the **Printer properties**.
 - 🔗 If **Printer properties** item has ? mark, you can select other printer drivers connected with selected printer.
6. Select the **Sharing** tab.
7. Check the **Change Sharing Options**.
8. Check the **Share this printer**.
9. Fill in the **Share Name** field. Click **OK**.

Setting up a client computer

1. Install your printer driver (See [Installing USB connected machine's driver](#)).
2. Click the Windows **Start** menu.
3. Select **All programs > Accessories > Windows Explorer**.
4. Enter in IP address of the host computer and press Enter in your keyboard.



- 🔗 In case host computer requires **User name** and **Password**, fill in User ID and password of the host computer account.
5. Right click the printer icon you want to share and select **Connect**.
6. If a set up complete message appears, click **OK**.
7. Open the file you want to print and start printing.

Macintosh

 The following steps are for Mac OS X 10.5 ~ 10.6. Refer to Mac Help for other OS versions.

Setting up a host computer

1. Install your printer driver (See [Macintosh](#)).
2. Open the **Applications** folder > **System Preferences** and click **Print & Fax**.
3. Select the printer to share in the **Printers list**.
4. Select **Share this printer**.

Setting up a client computer

1. Install your printer driver (See [Macintosh](#)).
2. Open the **Applications** folder > **System Preferences** and click **Print & Fax**.
3. Press the "+" icon.
A display window showing the name of your shared printer appears.
4. Select your machine and click **Add**.

Basic setup

After installation is complete, you may want to set the machine's default settings. Refer to the next section if you would like to set or change values. This chapter gives you step-by-step instructions for setting up the machine.

This chapter includes:

- [Altitude adjustment](#)
- [Changing the display language](#)
- [Setting the date and time](#)
- [Changing the clock mode](#)
- [Changing the default mode](#)
- [Setting sounds](#)
- [Entering characters using the number keypad](#)
- [Using the save modes](#)
- [Setting the default tray and paper](#)
- [Setting job timeout](#)

Altitude adjustment

The print quality is affected by atmospheric pressure, which is determined by the height of the machine above sea level. The following information will guide you on how to set your machine to the best print quality or best quality of print.

Before you set the altitude value, determine the altitude where you are.

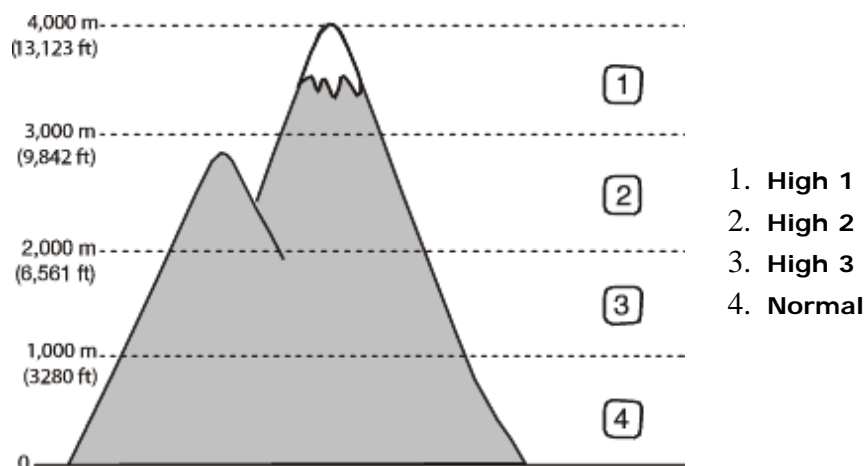

1. Ensure that you have installed the printer driver with the provided software CD.
 2. You can launch Printer Settings Utility from the **Start** menu, select **Programs** or **All Programs** > **Dell** > **Dell Printers** > **your printer driver name** > **Printer Settings Utility**.
 3. Click **Setting** > **Altitude Adjustment**. Select the appropriate value from the dropdown list, and then click **Apply**.
-  • If your machine is connected to a network, Embedded Web Service screen appears automatically. Click **Machine Settings** > **System Setup** > **Machine Setup** > **Altitude Adj**. Select the appropriate altitude value, and then click **Apply**.
- If your machine is connected via a USB cable, set the altitude in **Altitude Adj**. option on the machine's display.

Changing the display language

To change the language that appears on the display, follow the steps below:

1. Press **Menu** () on the control panel.
2. Press the left/right arrow until **System Setup** appears and press **OK**.
Press the left/right arrow until **Machine Setup** appears and press **OK**.

- 3.
4. Press the left/right arrow until **Language** appears and press **OK**.
5. Press the left/right arrow to display the language you want.
6. Press **OK** to save the selection.
7. Press **Stop/Clear** (⏹) to return to ready mode.

Setting the date and time

When you set the time and date, they are used in delay fax and delay print. They are printed on reports. If, however, they are not correct, you need to change it for the correct time being.

-  If the machine's power is cut off, you need to reset the correct time and date once the power has been restored.
1. Press **Menu** (☰) on the control panel.
 2. Press the left/right arrow until **System Setup** appears and press **OK**.
 3. Press the left/right arrow until **Machine Setup** appears and press **OK**.
 4. Press the left/right arrow until **Date & Time** appears and press **OK**.
 5. Enter the correct time and date using left/right arrow or numeric keypad.
Month = 01 to 12,
Day = 01 to 31,
Year = requires four digits,
Hour = 01 to 12,
Minute = 00 to 59,
and you can also select AM or PM.
 6. Press **OK** to save the selection.
 7. Press **Stop/Clear** (⏹) to return to ready mode.

Changing the clock mode

You can set your machine to display the current time using either a 12-hour or 24-hour format.

1. Press **Menu** (☰) on the control panel.
2. Press the left/right arrow until **System Setup** appears and press **OK**.
3. Press the left/right arrow until **Machine Setup** appears and press **OK**.
4. Press the left/right arrow until **Clock Mode** appears and press **OK**.
5. Press the left/right arrow to select the other mode and press **OK**.
6. Press **Stop/Clear** (⏹) to return to ready mode.

Changing the default mode

Your machine is preset to Copy mode. You can switch this default mode between Fax mode and Copy mode.

1. Press **Menu** (☰) on the control panel.
2. Press the left/right arrow until **System Setup** appears and press **OK**.
3. Press the left/right arrow until **Machine Setup** appears and press **OK**.
4. Press the left/right arrow until **Default Mode** appears and press **OK**.
5. Press the left/right arrow to select the mode you want.
6. Press **OK** to save the selection.
7. Press **Stop/Clear** (⏹) to return to ready mode.

Setting sounds

You can control the following sounds:

- **Key sound:** Turns the key sound **On** or **Off**. With this option set to **On**, a tone sounds each time a key is pressed.
- **Alarm Sound:** Turns the alarm sound **On** or **Off**. With this option set to **On**, an alarm tone sounds when an error occurs or fax communication ends.
- **Speaker:** Turns **On** or **Off** the sounds from the telephone line through the speaker, such as a dial tone or a fax tone. With this option set to **Comm.** which means "Common", the speaker is on until the remote machine answers.

-  You can adjust the volume level using **On Hook Dial**. If your machine has a handset, you can adjust the volume level using the handset.

- **Ringer:** Adjusts the ringer volume. For the ringer volume, you can select **Off**, **Low**, **Mid**, and **High**.

Speaker, ringer, key sound, and alarm sound

1. Press **Menu** (☰) on the control panel.
2. Press the left/right arrow until **System Setup** appears and press **OK**.
3. Press the left/right arrow until **Sound/Volume** appears and press **OK**.
4. Press the left/right arrow until the sound option you want appear and press **OK**.
5. Press the left/right arrow until the desired status or volume for the sound you have selected appears and press **OK**.
6. If necessary, repeat steps 4 through 5 to set other sounds.
7. Press **Stop/Clear** (⊗) to return to ready mode.

Speaker volume

To adjust the volume using **On Hook Dial**:

1. Press **Fax** (☎) on the control panel.
2. Press **On Hook Dial**. A dial tone sounds from the speaker.
3. Press the left/right arrow until you hear the volume you want.
4. Press **On Hook Dial** to save the change and return to ready mode.

If your machine has a handset:

1. Pick up the handset. A dial tone sounds from the earpiece.
2. Press the left/right arrow until you hear the volume you want.
3. Press **OK** to save the change and replace the handset.

 You can adjust the speaker volume only when the telephone line is connected.

Entering characters using the number keypad

As you perform various tasks, you may need to enter names and numbers. For example, when you set up your machine, you enter your name or your company's name, and the fax number.

Entering alphanumeric characters

1. When you are prompted to enter a letter, locate the button labeled with the character you want. Press the button until the correct letter appears on the display.
For example, to enter the letter O, press 6, labeled with MNO.
Each time you press 6, the display shows a different letter, M, N, O, m, n, o and finally 6.
You can enter special characters, such as space, plus sign, and etc. For details, see the below section.
2. To enter additional letters, repeat step 1.
If the next letter is printed on the same button, move the cursor by pressing the left/right arrow button and then press the button labeled with the letter you want. The cursor will move to the right and the next letter will appear on the display.
You can enter a space by pressing 1 twice.
3. When you have finished entering letters, press **OK**.

Keypad letters and numbers

Key	Assigned numbers, letters, or characters
1	@ / . ` 1
2	A B C a b c 2
3	D E F d e f 3
4	G H I g h i 4
5	J K L j k l 5
6	M N O m n o 6
7	P Q R S p q r s 7
8	T U V t u v 8
9	W X Y Z w x y z 9
0	& + - , 0
*	*

Correcting numbers or names

If you make a mistake while entering a number or name, press the left/right arrow button to delete the last digit or character. Then enter the correct number or character.



Inserting a pause

With some telephone systems, you must dial an access code (9, for example) and listen for a second dial tone. In such cases, you must insert a pause in the telephone number. You can insert a pause while you are setting up speed dial numbers. To insert a pause, press **Redial/Pause** at the appropriate place while entering the telephone number. A - appears on the display at the corresponding location.

Using the save modes

Using the toner saving feature



Toner save mode allows your machine to use less toner on each page. Activating this mode extends the life of the toner cartridge beyond what one would experience in the normal mode, but it reduces print quality.

1. Press **Menu** () on the control panel.
2. Press the left/right arrow until **System Setup** appears and press **OK**.
3. Press the left/right arrow until **Machine Setup** appears and press **OK**.
4. Press the left/right arrow until **Toner Save** appears and press **OK**.
5. Press the left/right arrow until **On** appears and press **OK**.
6. Press **Stop/Clear** () to return to ready mode.

 When PC-printing, you can also turn on or off toner save mode in the printer properties.

Using the power saving feature

When you are not using the machine for a while, use this feature to save power.

1. Press **Menu** () on the control panel.
2. Press the left/right arrow until **System Setup** appears and press **OK**.
3. Press the left/right arrow until **Machine Setup** appears and press **OK**.
4. Press the left/right arrow until **Power Save** appears and press **OK**.
5. Press the left/right arrow to select the time you want.
6. Press **OK** to save the selection.
7. Press **Stop/Clear** () to return to ready mode.



 Available settings range from 1-120 minutes. The factory default setting is 1 minute.

Setting the default tray and paper

You can select the tray and paper you would like to keep using for printing job.

In the control panel

Setting the paper size

1. Press **Menu** () on the control panel.
2. Press the left/right arrow until **System Setup** appears and press **OK**.
3. Press the left/right arrow until **Paper Setup** appears and press **OK**.
4. Press the left/right arrow until **Paper Size** appears and press **OK**.
5. Press the left/right arrow to select the paper tray you want and press **OK**.
6. Press the left/right arrow to select the paper size you want.
7. Press **OK** to save the selection.
8. Press **Stop/Clear** () to return to ready mode.

Setting the paper type

1. Press **Menu** () on the control panel.
2. Press the left/right arrow until **System Setup** appears and press **OK**.

3. Press the left/right arrow until **Paper Setup** appears and press **OK**.
4. Press the left/right arrow until **Paper Type** appears and press **OK**.
5. Press the left/right arrow to select the paper tray you want and press **OK**.
6. Press the left/right arrow to select the paper type you want.
7. Press **OK** to save the selection.
8. Press **Stop/Clear** (⏹) to return to ready mode.

Setting the paper source

1. Press **Menu** (☰) on the control panel.
2. Press the left/right arrow until **System Setup** appears and press **OK**.
3. Press the left/right arrow until **Paper Setup** appears and press **OK**.
4. Press the left/right arrow until **Paper Source** appears and press **OK**.
5. Press the left/right arrow until **Copy Tray** or **Fax Tray** appears and press **OK**.
6. Press the left/right arrow to select the paper tray you want.
7. Press **OK** to save the selection.
8. Press **Stop/Clear** (⏹) to return to ready mode.

In the computer

Windows

1. Click the Windows **Start** menu.
2. For Windows 2000, select **Settings > Printers**.
 - For Windows XP/2003, select **Printers and Faxes**.
 - For Windows 2008/Vista, select **Control Panel > Hardware and Sound > Printers**.
 - For Windows 7, select **Control Panel > Hardware and Sound > Devices and Printers**.
 - For Windows Server 2008 R2, select **Control Panel > Hardware > Devices and Printers**.
3. Right-click your machine.
4. For Windows XP/2003/2008/Vista, press **Printing Preferences**.
For Windows 7 and Windows Server 2008 R2, from context menus, select the **Printing Preferences**.
 - 📌 If **Printing Preferences** item has ? mark, you can select other printer drivers connected with selected printer.
5. Click **Paper** tab.
6. Select tray and its options, such as paper size and type.
7. Press **OK**.
- 📌 If you want to use special-sized paper such as a billing paper, select **Paper** tab > **Size > Edit...** in the **Printing Preferences** (See [Opening printing preferences](#)).

Macintosh

Macintosh users need to change the default setting manually each time they want to print using other settings.

1. Open a Macintosh application and select the file you want to print.
2. Open the **File** menu and click **Print**.
3. Go to **Paper Feed** pane.
4. Open the **File** menu and click **Print**.
5. Go to **Paper Feed**.
6. Set appropriate tray from which you want to print.
7. Go to **Paper** pane.
8. Set paper type to correspond to the paper loaded in the tray from which you want to print.
9. Click **Print** to print.



Linux

1. Open **Terminal Program**
2. When the Terminal screen appears, type in the following: `[root@localhost root]# lpr <FileName>`
3. Select **Printer** and click **Properties...**
4. Click **Advanced** tab.

5. Select tray (source) and its options, such as paper size and type.
6. Press **OK**.

Setting job timeout

When there is no input for a certain period of time, the machine exits the current menu and goes in to the default settings. You can set the amount of time the machine will wait.

1. Press **Menu** () on the control panel.
2. Press the left/right arrow until **System Setup** appears and press **OK**.
3. Press the left/right arrow until **Machine Setup** appears and press **OK**.
4. Press the left/right arrow until **Job Timeout** appears and press **OK**.
5. Enter the time using left/right arrow or numeric keypad.
6. Press **OK** to save the selection.
7. Press **Stop/Clear** () to return to ready mode.

Printing

This chapter explains common printing tasks.

This chapter includes:

- [Printer driver features](#)
- [Basic printing](#)
- [Opening printing preferences](#)
- [Using help](#)
- [Using special print features](#)
- [Changing the default print settings](#)
- [Setting your machine as a default machine](#)
- [Printing to a file \(PRN\)](#)
- [Macintosh printing](#)
- [Linux printing](#)

 The procedures in this chapter are mainly based on Windows XP.

Printer driver features

Your printer drivers support the following standard features:

- Paper orientation, size, source, and media type selection
- Number of copies

In addition, you can use various special printing features. The following table shows a general overview of features supported by your printer drivers:





Printer driver

Feature	Windows
Machine quality option	?
Booklet printing	?
Poster printing	?
Multiple pages per sheet	?
Fit to page printing	?
Reduce and enlarge printing	?
Different source for first page	?
Watermark	?
Overlay	?
Double-sided printing (manual)	?

(?: supported)

Basic printing

Your machine allows you to print from various Windows, Macintosh, or Linux applications. The exact steps for printing a document may vary depending on the application you use.

-  Your **Printing Preferences** window that appears in this user's guide may differ depending on the machine in use. However, the composition of the **Printing Preferences** window is similar. Check the operating system(s) that are compatible with your machine. Refer to the OS compatibility section of Printer Specifications (See [System requirements](#)).
- When you select an option in **Printing Preferences**, you may see a warning mark, , or . An exclamation mark () means you can select that certain option but it is not recommended, and () mark means you

cannot select that option due to the machine's setting or environment.

The following procedure describes the general steps required for printing from various Windows applications.

 Macintosh basic printing (See [Macintosh printing](#)).

Linux basic printing (See [Linux printing](#)).

The following **Printing Preferences** window is for Notepad in Windows XP. Your **Printing Preferences** window may differ, depending on your operating system or the application you are using.

1. Open the document you want to print.
2. Select **Print** from the **File** menu. The **Print** window appears.
3. Select your machine from the **Select Printer** list.

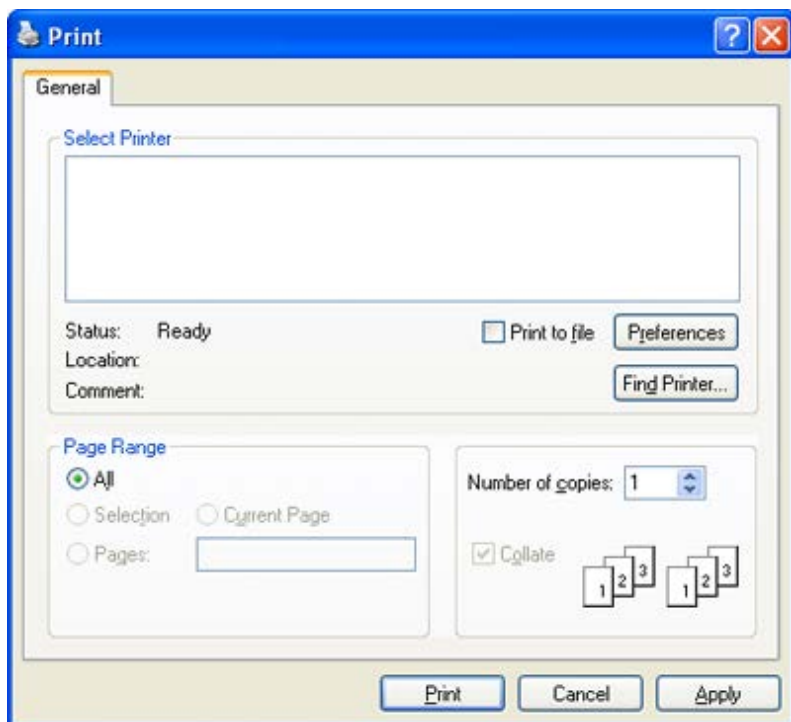

The basic print settings including the number of copies and print range are selected within the **Print** window.

 To take advantage of the printer features provided by your printer driver, click **Properties** or **Preferences** in the application's **Print** window to change the print setting (See [Opening printing preferences](#)).

4. To start the print job, click **OK** or **Print** in the **Print** window.

 If you are using Windows Internet Explorer, the **Dell AnyWeb Print** tool will save your time for screen-captured images or printing the image. Click **Start > All programs > Dell Printers > Dell AnyWeb Print > Download the latest version** to link the website where the tool is available for the download.



Canceling a print job

If the print job is waiting in a print queue or print spooler, cancel the job as follows:

1. Click the Windows **Start** menu.
2. For Windows 2000, select **Settings > Printers**.
 - For Windows XP/2003, select **Printer and Faxes**.
 - For Windows 2008/Vista, select **Control Panel > Hardware and Sound > Printers**.
 - For Windows 7, select **Control Panel > Hardware and Sound > Devices and Printers**.
 - For Windows Server 2008 R2, select **Control Panel > Hardware > Devices and Printers**.
3. For Windows 2000, XP, Server 2003, Vista, or Server 2008, double-click your machine.
For Windows 7, or Windows Server 2008 R2, right click your printer icon > context menus > **See what's printing**.

 If **See what's printing** item has ? mark, you can select other printer drivers connected with selected printer.

4. From the **Document** menu, select **Cancel**.

 You can also access this window by simply double-clicking the machine icon () in the Windows task bar.

You can also cancel the current job by pressing **Stop/Clear** () on the control panel.

Opening printing preferences

You can preview the settings you selected on the upper right of the **Printing Preferences**.

1. Open the document you want to print.
2. Select **Print** from the file menu. The **Print** window appears.
3. Select your machine from the **Select Printer**.
4. Click **Properties** or **Preferences**.

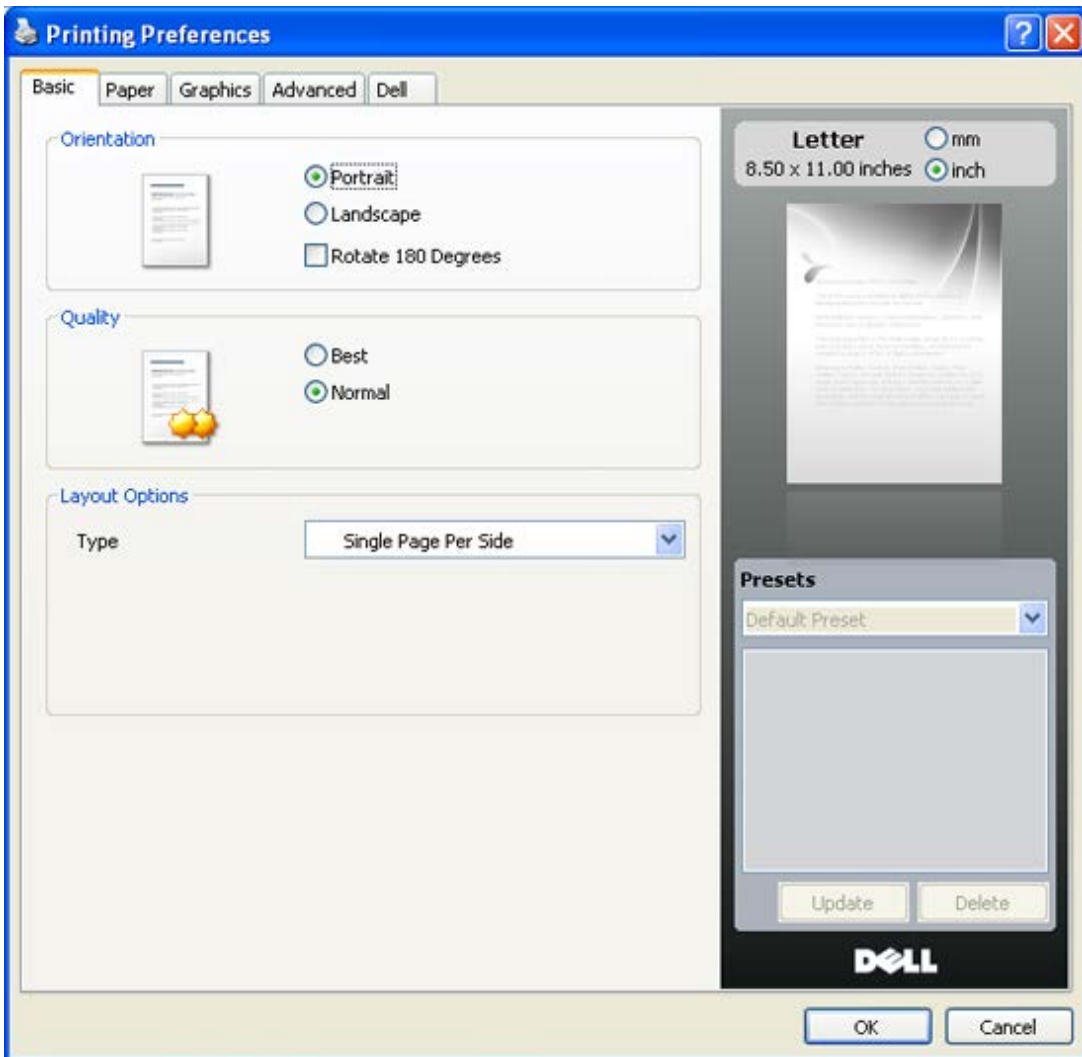

Using a Presets setting

The **Presets** option, which is visible on each preferences tab except for **Dell** tab, allows you to save the current preferences settings for future use.

To save a **Presets** item:

1. Change the settings as needed on each tab.
2. Enter a name for the item in the **Presets** input box.

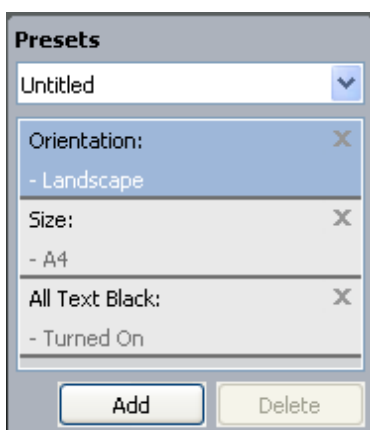

3. Click **Add**. When you save **Presets**, all current driver settings are saved.

If you click **Add**, the **Add** button changes to **Update** button. Select more options and click **Update**, settings will be

added to the **Presets** you made.

To use a saved setting, select it from the **Presets** drop down list. The machine is now set to print according to the setting you selected.

To delete saved setting, select it from the **Presets** drop down list and click **Delete**.

You can also restore the printer driver's default settings by selecting **Default Preset** from the **Presets** drop down list.

Using help

Click the question mark from the upper-right corner of the window and click on any option you want to know about. Then a pop up window appears with information about that option's feature which is provided from the driver.



If you want to search information via a keyword, click the **Dell** tab in the **Printing Preferences** window, and enter a keyword in the input line of the **Help** option.

Using special print features

Special print features include:

- [Printing multiple pages on one sheet of paper.](#)
- [Printing posters.](#)
- [Printing booklets \(Manual\).](#)
- [Printing on both sides of paper \(Manual\).](#)
- [Change percentage of your document.](#)
- [Fitting your document to a selected paper size.](#)
- [Using watermarks.](#)
- [Using overlay.](#)
- [Advanced Options.](#)

Printing multiple pages on one sheet of paper

You can select the number of pages to print on a single sheet of paper. To print more than one page per sheet, the pages will be reduced in size and arranged in the order you specify. You can print up to 16 pages on one sheet.

1. To change the print settings from your software application, access **Printing Preferences** (See [Opening printing preferences](#)).
2. Click the **Basic** tab, select **Multiple Pages per Side** in the **Type** drop-down list.
3. Select the number of pages you want to print per sheet (2, 4, 6, 9, or 16) in the **Pages per Side** drop-down list.
4. Select the page order from the **Page Order** drop-down list, if necessary.
5. Check **Print Page Border** to print a border around each page on the sheet.
6. Click the **Paper** tab, select the **Size**, **Source**, and **Type**.
7. Click **OK** or **Print** until you exit the **Print** window.

Printing posters

This feature allows you to print a single-page document onto 4, 9, or 16 sheets of paper, for the purpose of pasting the sheets together to form one poster-size document.

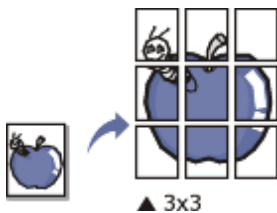

1. To change the print settings from your software application, access **Printing Preferences** (See [Opening printing preferences](#)).
2. Click the **Basic** tab, select **Poster Printing** in the **Type** drop-down list.
3. Select the page layout you want.

Specification of the page layout:

- **Poster 2x2**: Document will be enlarged and be divided into 4 pages.

Poster 3x3: Document will be enlarged and be divided into 9 pages.

- **Poster 4x4:** Document will be enlarged and be divided into 16 pages.

4. Select the **Poster Overlap** value. Specify **Poster Overlap** in millimeters or inches by selecting the radio button on the upper right of **Basic** tab to make it easier to paste the sheets together.



5. Click the **Paper** tab, select the **Size**, **Source**, and **Type**.
6. Click **OK** or **Print** until you exit the **Print** window.
7. You can complete the poster by pasting the sheets together.



Printing booklets (Manual)

This feature prints your document on both sides of a paper and arranges the pages so that the paper can be folded in half after printing to produce a booklet.

-  If you want to make a booklet, you need to print on Letter, Legal, A4, Us Folio, or Oficio sized print media.



1. To change the print settings from your software application, access the **Printing Preferences** (See [Opening printing preferences](#)).
2. Click the **Basic** tab, select **Booklet Printing** from the **Type** drop-down list.
3. Click the **Paper** tab, select the **Size**, **Source**, and **Type**.

-  The **Booklet Printing** option is not available for all paper sizes. In order to find out the available paper size for this feature, select the available paper size in the **Size** option on the **Paper** tab. If you select an unavailable paper size, this option can be automatically canceled. Select only available paper (paper without  or  mark).

4. Click **OK** or **Print** until you exit the **Print** window.
5. After printing, fold and staple the pages.

Printing on both sides of paper (Manual)

You can print on both sides of a paper; duplex. Before printing, decide how you want your document oriented. You can use this feature with Letter, Legal, A4, US Folio, or Oficio sized paper (See [Print media specifications](#)).

-  It is recommended not to print on both sides of a special media, such as labels, envelopes, or thick paper. It may cause a paper jam or damage the machine.

1. To change the print settings from your software application, access **Printing Preferences** (See [Opening printing preferences](#)).
2. Click the **Advance** tab.
3. From the **Double-Sided Printing (Manual)** section, select the binding option you want.
 - **None**
 - **Long Edge:** This option is the conventional layout used in bookbinding.



- **Short Edge:** This option is the conventional layout used in calendars.



4. Click the **Paper** tab, select the **Size**, **Source**, and **Type**.

5. Click **OK** or **Print** until you exit the **Print** window.

-  If your machine does not have a duplex unit, you should complete the printing job manually. The machine prints every alternate page of the document first. After that, an instruction message appears on your computer. Follow the on-screen instructions to complete the printing job.

Change percentage of your document

You can change the size of a document to appear larger or smaller on the printed page by typing in a percentage you want.

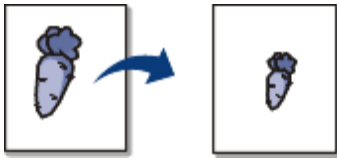

1. To change the print settings from your software application, access **Printing Preferences** (See [Opening printing preferences](#)).
2. Click the **Paper** tab.
3. Enter the scaling rate in the **Percentage** input box.
You can also click the up/down arrows to select the scaling rate.
4. Select the **Size**, **Source**, and **Type** in **Paper Options**.
5. Click **OK** or **Print** until you exit the **Print** window.

Fitting your document to a selected paper size

This printer feature allows you to scale your print job to any selected paper size regardless of the document size. This can be useful when you want to check fine details on a small document.

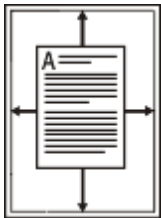

1. To change the print settings from your software application, access **Printing Preferences** (See [Opening printing preferences](#)).
2. Click the **Paper** tab.
3. Select the paper size you want from the **Fit to page**.
4. Select the **Size**, **Source**, and **Type** in **Paper Options**.
5. Click **OK** or **Print** until you exit the **Print** window.

Using watermarks

The watermark option allows you to print text over an existing document. For example, you use it when you want to have large gray letters reading "DRAFT" or "CONFIDENTIAL" printed diagonally across the first page or all pages of a document.

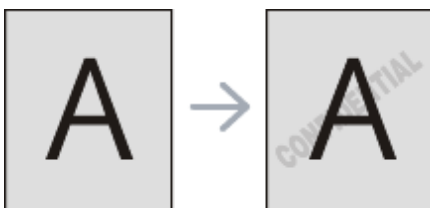

There are several predefined watermarks that come with the machine. They can be modified, or you can add new ones to the list.

Using an existing watermark

1. To change the print settings from your software application, access **Printing Preferences** (See [Opening printing preferences](#)).
2. Click the **Advanced** tab, and select the desired watermark from the **Watermark** drop-down list. You will see the selected watermark in the preview image.
3. Click **OK** or **Print** until you exit the print window.

Creating a watermark

1. To change the print settings from your software application, access **Printing Preferences** (See [Opening printing preferences](#)).

2. From the **Advanced** tab, select **Edit** from the **Watermark** drop-down list. The **Edit Watermarks** window appears.
3. Enter a text message in the **Watermark Message** box. You can enter up to 256 characters. The message displays in the preview window.
When the **First Page Only** box is checked, the watermark prints on the first page only.
4. Select watermark options.
You can select the font name, style, size, and shade from the **Font Attributes** section, as well as set the angle of the watermark from the **Message Angle** section.
5. Click **Add** to add a new watermark to the **Current Watermarks** list.
6. When you have finished editing, click **OK** or **Print** until you exit the **Print** window.

To stop printing the watermark, select **None** from the **Watermark** drop-down list.

Editing a watermark

1. To change the print settings from your software application, access **Printing Preferences** (See [Opening printing preferences](#)).
2. Click the **Advanced** tab, select **Edit** from the **Watermark** drop-down list. The **Edit Watermarks** window appears.
3. Select the watermark you want to edit from the **Current Watermarks** list and change the watermark message and options.
4. Click **Update** to save the changes.
5. Click **OK** or **Print** until you exit the **Print** window.

Deleting a watermark

1. To change the print settings from your software application, access **Printing Preferences** (See [Opening printing preferences](#)).
2. Click the **Advanced** tab, select **Edit** from the **Watermark** drop-down list. The **Edit Watermarks** window appears.
3. Select the watermark you want to delete from the **Current Watermarks** list and click **Delete**.
4. Click **OK** or **Print** until you exit the **Print** window.

Using overlay

An overlay is text and/or images stored in the computer hard disk drive (HDD) as a special file format that can be printed on any document. Overlays are often used to take the place of letterhead paper. Rather than using preprinted letterhead, you can create an overlay containing exactly the same information that is currently on your letterhead. To print a letter with your company's letterhead, you do not need to load preprinted letterhead paper in the machine just print the letterhead overlay on your document.

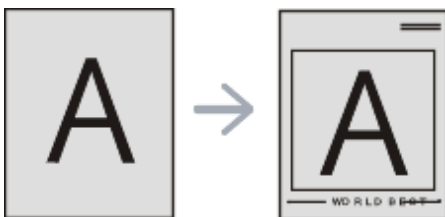

Creating a new page overlay

To use a page overlay, you must create a new page overlay containing your logo or image.

1. Create or open a document containing text or an image for use in a new page overlay. Position the items exactly as you wish them to appear when printed as an overlay.
2. To save the document as an overlay, access **Printing Preferences** (See [Opening printing preferences](#)).
3. Click the **Advanced** tab, and select **Edit** from the **Text** drop-down list. **Edit Overlay** window appears.
4. In the **Edit Overlay** window, click **Create**.
5. In the **Save As** window, type a name of up to eight characters in the **File name** box. Select the destination path, if necessary (The default is C:\Formover).
6. Click **Save**. The name appears on the **Overlay List**.
7. Click **OK** or **Print** until you exit the **Print** window.
8. The file is not printed. Instead, it is stored on your computer hard disk drive.

 The overlay document size must be the same as the document you print with the overlay. Do not create an overlay with a watermark.

Using a page overlay

After an overlay has been created, it is ready to be printed with your document. To print an overlay with a

document:

1. Create or open the document you want to print.
 2. To change the print settings from your software application, access **Printing Preferences** (See [Opening printing preferences](#)).
 3. Click the **Advanced** tab.
 4. Select the desired overlay from the **Text** drop-down list.
 5. If the overlay file you want does not appear in the **Text** drop-down list, select **Edit** from the list and click **Load**. Select the overlay file you want to use.
If you have stored the overlay file you want to use in an external source, you can also load the file when you access the **Open** window.
After you select the file, click **Open**. The file appears in the **Overlay List** box and is available for printing. Select the overlay from the **Overlay List** box.
 6. If necessary, check **Confirm Page Overlay When Printing** box. If this box is checked, a message window appears each time you submit a document for printing, asking you to confirm your wish to print an overlay on your document.
If this box is not checked and an overlay has been selected, the overlay automatically prints with your document.
 7. Click **OK** or **Print** until you exit the **Print** window.
The selected overlay prints on your document.
-  The resolution of the overlay document must be the same as that of the document you will print with the overlay.



Deleting a page overlay

You can delete page overlays that you no longer use.

1. In the **Printing Preferences** window, click the **Advanced** tab.
2. Select **Edit** in the **Overlay** drop down list.
3. Select the overlay you want to delete from the **Overlay List** box.
4. Click **Delete**.
5. When a confirming message window appears, click **Yes**.
6. Click **OK** or **Print** until you exit the **Print** window.



Advanced Options

Use the following Graphics options to adjust the print quality for your specific printing needs.

-  If the option is grayed out or not shown, that option is not applicable with the printer language you are using.
1. To change the print settings from your software application, access **Printing Preferences** (See [Opening printing preferences](#)).
 2. Click the **Graphics** tab.
 -  Refer to the online help for each option's information provided from the **Printing Preferences**.
 - **Font/Text:** Select **Darken Text** to print texts darker than on a normal document. Use **All Text Black** to prints solid black, regardless of the color it appears on the screen.
 - **Graphic Controller:** **Fine Edge** allows user to emphasize edges of texts and fine lines for improving readability.
 - **Toner Save:** Selecting this option extends the life of your toner cartridge and reduces your cost per page without a significant reduction in print quality.
 - **On:** Select this option to allow the printer to use less toner on each page.
 - **Off:** If you do not need to save toner when printing a document, select this option.
 3. Click **OK** or **Print** until you exit the **Print** window.

Changing the default print settings

1. Click the Windows **Start** menu.
2. For Windows 2000, select **Settings > Printers**.
 - For Windows XP/2003, select **Printer and Faxes**.
 - For Windows 2008/Vista, select **Control Panel > Hardware and Sound > Printers**.
 - For Windows 7, select **Control Panel > Hardware and Sound > Devices and Printers**.
 - For Windows Server 2008 R2, select **Control Panel > Hardware > Devices and Printers**.
3. Right-click your machine.

4. For Windows XP/2003/2008/Vista, press **Printing Preferences**.
For Windows 7 and Windows Server 2008 R2, from context menus, select the **Printing preferences**.
 If **Printing preferences** item has ? mark, you can select other printer drivers connected with selected printer.
 5. Change the settings on each tab.
 6. Click **OK**.
-  If you want to change the settings for each print job, change it in **Printing Preferences**.

Setting your machine as a default machine

1. Click the Windows **Start** menu.
2. For Windows 2000, select **Settings > Printers**.
 - For Windows XP/2003, select **Printer and Faxes**.
 - For Windows 2008/Vista, select **Control Panel > Hardware and Sound > Printers**.
 - For Windows 7, select **Control Panel > Hardware and Sound > Devices and Printers**.
 - For Windows Server 2008 R2, select **Control Panel > Hardware > Devices and Printers**.
3. Select your machine.
4. Right-click your machine and select **Set as Default Printer**.
 For Windows 7 and Windows Server 2008 R2. If **Set as default printer** item has ? mark, you can select other printer drivers connected with selected printer.

Printing to a file (PRN)

You will sometimes need to save the print data as a file.

To create a file:

1. Check the **Print to file** box at the **Print** window.

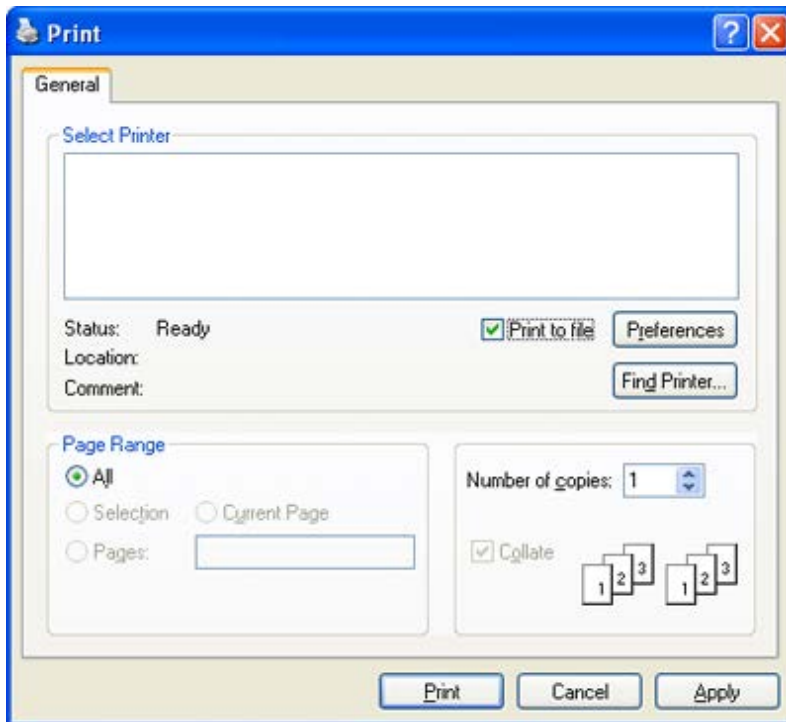

2. Click **Print**.
3. Type in the destination path and the file name, and then click **OK**. For example **c:\Temp\file name**.
 If you type in only the file name, the file is automatically saved in **My Documents**. The saved folder may differ, depending on your operating system.

Macintosh printing

This section explains how to print using Macintosh. You need to set the print environment before printing.

- USB connected (See [Macintosh](#)).
- Network connected (See [Macintosh](#)).

Printing a document

When you print with a Macintosh, you need to check the printer driver setting in each application you use. Follow the steps below to print from a Macintosh:

1. Open the document you want to print.
2. Open the **File** menu and click **Page Setup**.
3. Choose your paper size, orientation, scaling, other options, and make sure that your machine is selected. Click **OK**.

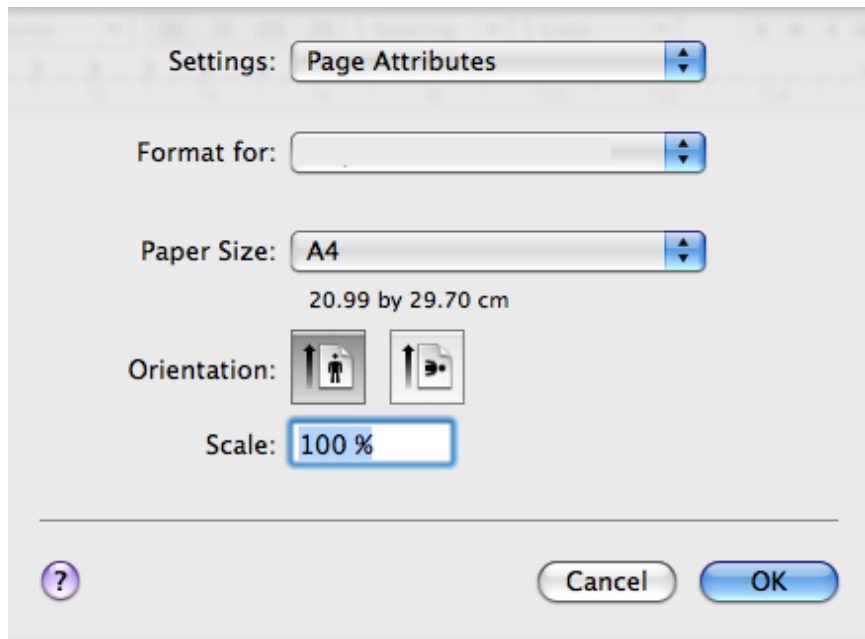

4. Open the **File** menu and click **Print**.
5. Choose the number of copies you want and indicate which pages you want to print.
6. Click **Print**.

Changing printer settings

You can use advanced printing features provided by your machine.

Open an application and select **Print** from the **File** menu. The machine name, which appears in the printer properties pane may differ depending on the machine in use. Except for the name, the composition of the printer properties pane is similar to the following.

- The setting options may differ depending on printers and Mac OS version.
- The following pane may differ, depending on your operating system or the application you are using.

The following pane is the first pane you will see when you open the printer properties pane. Select other advanced features from the drop down list.

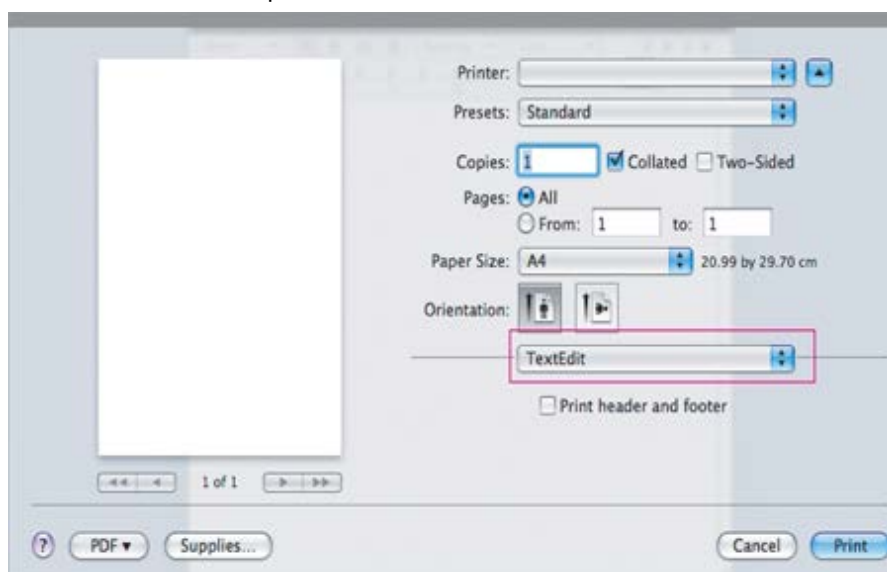

Layout

The **Layout** tab provides options to adjust how the document appears on the printed page. You can print multiple

pages on one sheet of paper. Select **Layout** from the drop-down list under **Orientation** to access the following features.

- **Pages per Sheet:** This option determines how many pages to be printed on one page (See [Printing multiple pages on one sheet of paper](#)).
- **Layout Direction:** This option allows you to select the printing direction on a page similar to the examples on UI.
- **Border:** This option allows you to print a border around each page on the sheet.
- **Reverse Page Orientation:** This option allows you to rotate paper 180 degrees.

Graphics

The **Graphics** tab provides options for selecting **Resolution**. Select **Graphics** from the drop-down list under **Orientation** to access the graphic features.

- **Resolution (Quality):** This option allows you to select the printing resolution. The higher the setting, the sharper the clarity of printed characters and graphics. The higher setting also may increase the time it takes to print a document.

Paper

Set **Paper Type** to correspond to the paper loaded in the tray from which you want to print. This will let you get the best quality printout. If you load a different type of print material, select the corresponding paper type.

Printer Settings

Printer Settings tab provides **Toner Save** options. Select **Printer Settings** from the drop-down list under **Orientation** to access the following features:

- **Toner Save:** Selecting this option extends the life of your toner cartridge and reduces your cost per page without a significant reduction in print quality.
 - **On:** Select this option to allow the printer to use less toner on each page.
 - **Off:** If you do not need to save toner when printing a document, select this option.

Printing multiple pages on one sheet of paper

You can print more than one page on a single sheet of paper. This feature provides a cost-effective way to print draft pages.

1. Open an application, and select **Print** from the **File** menu.
2. Select **Layout** from the drop-down list under **Orientation**. In the **Pages per Sheet** drop-down list, select the number of pages you want to print on one sheet of paper.

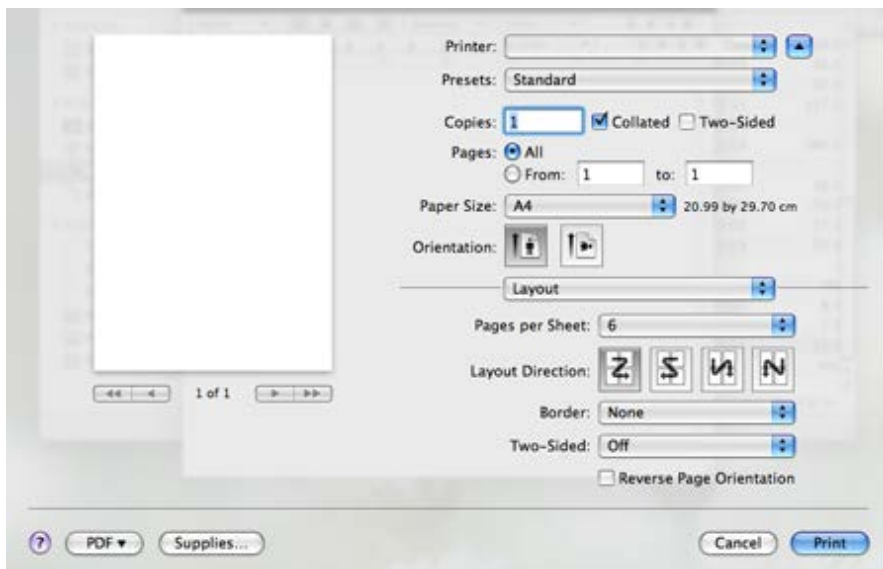

3. Select the other options you want to use.
4. Click **Print**, then the machine prints the selected number of pages you want to print on one sheet of paper.

Linux printing

Printing from applications

There are a lot of Linux applications that allow you to print using Common UNIX Printing System (CUPS). You can print on your machine from any such application.

1. Open an application, and select **Print** from the **File** menu.
2. Select **Print** directly using `lpr`.

3. In the LPR GUI window, select the model name of your machine from the printer list and click **Properties**.

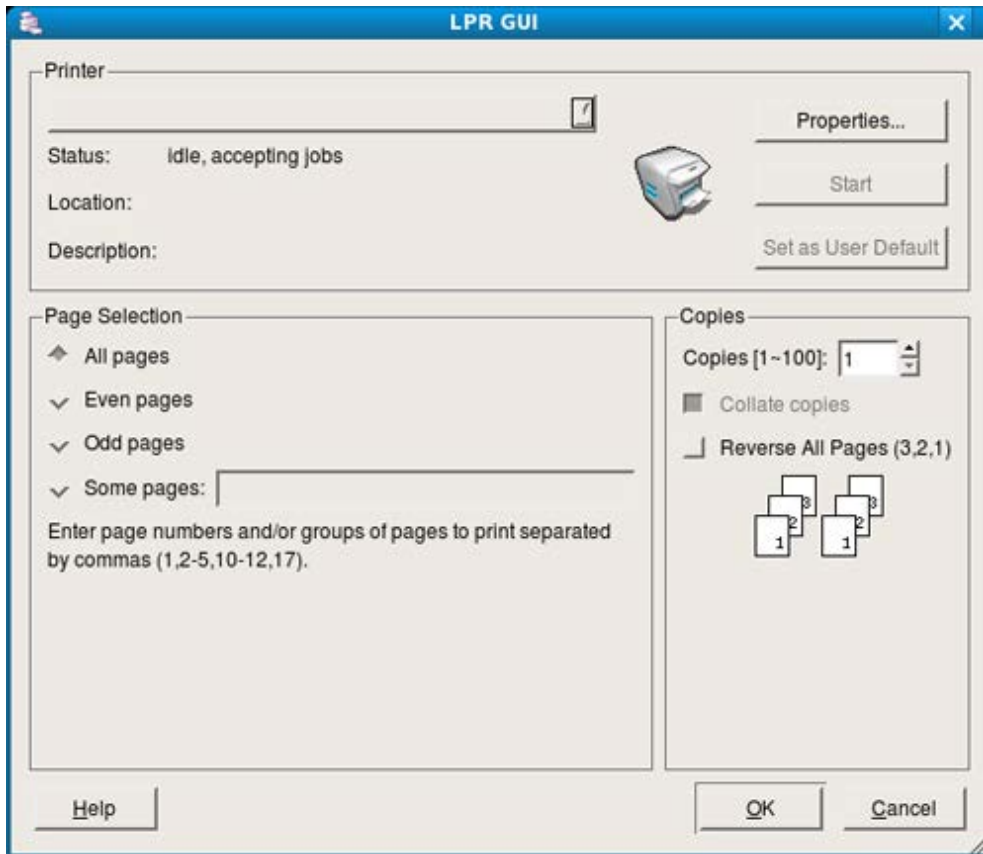

4. Change the print job properties using the following four tabs displayed at the top of the window.
 - **General:** This option allows you to change the paper size, the paper type, and the orientation of the documents. It enables the duplex feature, adds start and end banners, and changes the number of pages per sheet.
 - **Text:** This option allows you to specify the page margins and set the text options, such as spacing or columns.
 - **Graphics:** This option allows you to set image options that are used when printing image files, such as color options, image size, or image position.
 - **Advanced:** This option allows you to set the print resolution, paper, source and special print features.
- If an option is grayed out, it means that the grayed out option is not supported.
5. Click **Apply** to apply the changes and close the **Properties** window.
6. Click **OK** in the **LPR GUI** window to start printing.
7. The Printing window appears, allowing you to monitor the status of your print job.
To abort the current job, click **Cancel**.

Printing files

You can print many different types of files on your machine using the standard CUPS way, directly from the command line interface. The CUPS lpr utility allows you to do that. But the drivers package replaces the standard lpr tool by a much more user-friendly LPR GUI program.

To print any document file:

1. Type `lpr <file_name>` from the Linux shell command line and press **Enter**. The **LPR GUI** window appears.
When you type only `lpr` and press **Enter**, the **Select file(s) to print** window appears first. Just select any files you want to print and click **Open**.
2. In the **LPR GUI** window, select your machine from the list, and change the print job properties.
3. Click **OK** to start printing.

Configuring Printer Properties

Using the **Printer Properties** window provided by the **Printers configuration**, you can change the various properties for your machine as a printer.

1. Open the **Unified Driver Configurator**.
If necessary, switch to **Printers configuration**.
2. Select your machine on the available printers list and click **Properties**.
3. The **Printer Properties** window opens.

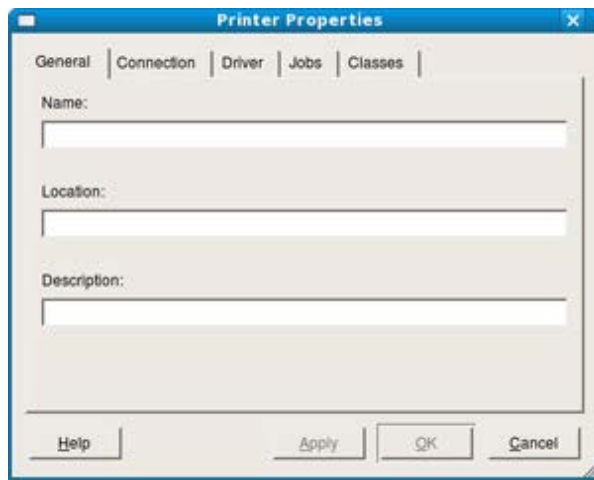

The following five tabs display at the top of the window:

- **General:** This option allows you to change the printer location and name. The name entered in this tab displays on the printer list in **Printers configuration**.
- **Connection:** This option allows you to view or select another port. If you change the machine port from USB to parallel or vice versa while in use, you must re-configure the machine port in this tab.
- **Driver:** This option allows you to view or select another machine driver. By clicking **Options**, you can set the default device options.
- **Jobs:** This option shows the list of print jobs. Click **Cancel job** to cancel the selected job and select the **Show completed jobs** check box to see previous jobs on the job list.
- **Classes:** This option shows the class that your machine is in. Click **Add to Class** to add your machine to a specific class or click **Remove from Class** to remove the machine from the selected class.

4. Click **OK** to apply the changes and close the **Printer Properties** window.

Copying

This chapter gives you step-by-step instructions for copying documents.



This chapter includes:



- [Basic copy](#)
- [Changing the settings for each copy](#)
- [Changing the default copy settings](#)
- [Using special copy features](#)
- [Deciding the form of copy output](#)
- [Setting copy timeout](#)

 Supported optional devices and features may differ according to your printer model. (See [Features by Model](#)).

Basic copy



This is the normal and usual procedure for copying your originals.

1. Press **Copy** () on the control panel.
2. Load originals face up into the document feeder, or place a single original face down on the scanner glass. (See [On the scanner glass](#) or [In the document feeder](#)).
3. If necessary, adjust the settings for each copy such as **Reduce/Enlarge**, **Darkness**, **Original Type** and more (See [Changing the settings for each copy](#)).
4. Enter the number of copies using the arrow or number keypad, if necessary.
5. Press **Start** () on the control panel to begin copying.

 To cancel the current copy job, press **Stop/Clear** () on the control panel.



Changing the settings for each copy

Your machine provides default settings for copying so that you can quickly and easily make a copy. However, if you want to change the options for each copy, use the copy function buttons on the control panel.

 If you press **Stop/Clear** () while setting the copy options, all of the options you have set for the current copy job will be canceled and return to their default status after the machine completes the copy in progress.

Changing the darkness



If you have an original containing faint marking and dark images, you can adjust the brightness to make a copy that is easier to read.

1. Press **Copy** () on the control panel.
2. Press **Menu** () on the control panel.
3. Press the left/right arrow until **Copy Feature** appears and press **OK**.
4. Press the left/right arrow until **Darkness** appears and press **OK**.
5. Press the left/right arrow until the contrast mode you want appears and press **OK**.
 - **Light**: Works well with dark print.
 - **Lightest**: Works well with darker print.
 - **Normal**: Works well with standard typed or printed originals.
 - **Dark**: Works well with light print.
 - **Darkest**: Works well with lighter print or faint pencil markings.
6. Press **Stop/Clear** () to return to ready mode.

Selecting the type of originals

The original type setting is used to improve the copy quality by selecting the document type for the current copy



job.

1. Press **Copy** () on the control panel.
2. Press **Menu** () on the control panel.
3. Press the left/right arrow until **Copy Feature** appears and press **OK**.
4. Press the left/right arrow until **Original Type** appears and press **OK**.
5. Press the left/right arrow until the image mode you want appears and press **OK**.
 - **Text**: Use for originals containing mostly text.
 - **Text/Photo**: Use for originals with mixed text and photographs.
 - **Photo**: Use when the originals are photographs.
6. Press **Stop/Clear** () to return to ready mode.



Reducing or enlarging copies

You can reduce or enlarge the size of a copied image from 25% to 400% when you copy original documents from the scanner glass, or from 25% to 100% from the ADF.

To select from the predefined copy sizes:

1. Press **Copy** () on the control panel.
2. Press **Menu** () on the control panel.
3. Press the left/right arrow until **Copy Feature** appears and press **OK**.
4. Press the left/right arrow until **Reduce/Enlarge** appears and press **OK**.
5. Press the left/right arrow until the size setting you want appears and press **OK**.
6. Press **Stop/Clear** () to return to ready mode.



To scale the copy by directly entering the scale rate:



1. Press **Copy** () on the control panel.
2. Press **Menu** () on the control panel.
3. Press the left/right arrow until **Copy Feature** appears and press **OK**.
4. Press the left/right arrow until **Reduce/Enlarge** appears and press **OK**.
5. Press the left/right arrow until **Custom** appears and press **OK**.
6. Press the left/right arrow or numeric keypad to enter the copy size you want. Pressing and holding the left/right arrow allows you to quickly scroll to the number you want.
7. Press **OK** to save the selection.
8. Press **Stop/Clear** () to return to ready mode.

 When you make a reduced copy, black lines may appear at the bottom of your copy.

Changing the default copy settings

The copy options, including darkness, original type, copy size, collation, and number of copies, can be set to those most frequently used. When you copy a document, the default settings are used unless they have been changed by using the corresponding buttons on the control panel.

1. Press **Copy** () on the control panel.
2. Press **Menu** () on the control panel.
3. Press the left/right arrow until **Copy Setup** appears and press **OK**.
4. Press the left/right arrow until **Change Default** appears and press **OK**.
5. Press the left/right arrow until the setup option you want appears and press **OK**.
6. Press the left/right arrow until the setting you want appears and press **OK**.
7. Repeat steps 5 through 6, as needed.
8. Press **Stop/Clear** () to return to ready mode.

 While you are setting copy options, pressing **Stop/Clear** () cancels the changed settings and restores the defaults.

Using special copy features

You can use the following copy features:

ID card copying

Your machine can print 2-sided originals on one sheet of paper. Your machine can print 2-sided originals on one sheet of A4-, Letter-, Legal-, Folio-, Executive-, B5, A5, or A6-sized paper.

The machine prints one side of the original on the upper half of the paper and the other side on the lower half without reducing the size of the original. This feature is helpful for copying a small-sized item, such as a business card.

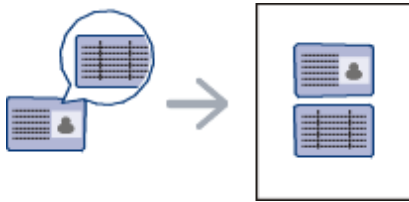

- This copy feature is available only when you place originals on the scanner glass.
 - The size of the 2-sided originals should be smaller than A5, if not, some of it won't be copied.
1. Press **ID Copy** on the control panel.
 2. **Place Front Side and Press [Start]** appears on the display.
 3. Place the front side of an original facing down on the scanner glass where arrows indicate as shown, and close the scanner lid.

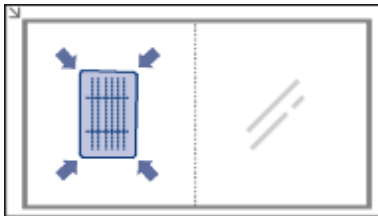

4. Press **OK** on the control panel.
Your machine begins scanning the front side and shows **Place Back Side and Press [Start]**.
5. Turn the original over and place it on the scanner glass, where arrows indicate as shown then, close the scanner lid.

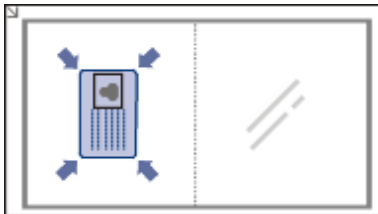

6. Press **OK** on the control panel to begin copying.

- If the original is larger than the printable area, some portions may not be printed.
- If you don't press the **OK** button, only the front side will be copied.
- If you press **Stop/Clear** (⏹), the machine cancels the copy job and returns to ready mode.

2-up or 4-up copying (N-up)

The machine reduces the size of the original images and prints 2 or 4 pages onto one sheet of paper.

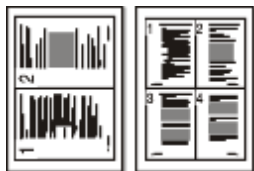

1. Press **Copy** (📄) on the control panel.
2. Press **Menu** (☰) on the control panel.
3. Press the left/right arrow until **Copy Feature** appears and press **OK**.
4. Press the left/right arrow until **Layout** appears and press **OK**.
5. Press the left/right arrow until **2-Up** or **4-Up** appears and press **OK**.
6. When **Yes** appears, press **OK**.
7. Press **Start** (▶) on the control panel to begin copying.





 You cannot adjust the copy size using **Reduce/Enlarge** for the **N-Up** feature.

Poster copying

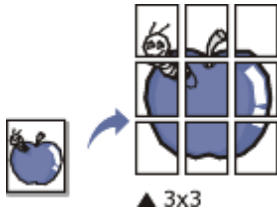
Your original will be divided into 9 portions. You can paste the printed pages together to make one poster-sized document.

This copy feature is available only when you place originals on the scanner glass.



1. Press **Copy** () on the control panel.
2. Press **Menu** () on the control panel.
3. Press the left/right arrow until **Copy Feature** appears and press **OK**.
4. Press the left/right arrow until **Layout** appears and press **OK**.
5. Press the left/right arrow until **Poster Copy** appears and press **OK**.
6. Press **Stop/Clear** () to return to ready mode.
7. Press **Start** () on the control panel to begin copying.

 Your original is divided into 9 portions. Each portion is scanned and printed one by one in the following order:



1	2	3
4	5	6
7	8	9

Clone copying

The machine prints multiple original images on a single page. The number of images is automatically determined by the original image and the paper size.

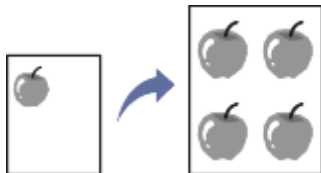
This copy feature is available only when you place originals on the scanner glass.





1. Press **Copy** () on the control panel.
2. Press **Menu** () on the control panel.
3. Press the left/right arrow until **Copy Feature** appears and press **OK**.
4. Press the left/right arrow until **Layout** appears and press **OK**.
5. Press the left/right arrow until **Clone Copy** appears and press **OK**.
6. When **Yes** appears, press **OK**.
7. Press **Start** () on the control panel to begin copying.

 You cannot adjust the copy size using **Reduce/Enlarge** for the **Clone Copy** feature.

Erasing background images

This feature is helpful when copying originals containing color in the background, as in newspapers or catalogs.

1. Press **Copy** () on the control panel.
2. Press **Menu** () on the control panel.
3. Press the left/right arrow until **Copy Feature** appears and press **OK**.
4. Press the left/right arrow until **Adjust Bkgd.** appears and press **OK**.
5. Press the left/right arrow until the binding option you want appears.
 - **Off**: Disables this feature.
 - **Auto**: Optimizes the background.

- **Enhance Lev.1~2:** The higher the number is, the more vivid the background is.
- **Erase Lev.1~4:** The higher the number is, the lighter the background is.

6. Press **OK** to save the selection.

7. Press **Stop/Clear** (⏹) to return to ready mode.

Deciding the form of copy output

You can set the machine to sort the copy job. For example, if you make 2 copies of a 3 page original, one complete 3 page document will print followed by a second complete document.

1. Press **Copy** (📄) on the control panel.
2. Place originals, face up, in the document feeder. Or you can use the scanner glass with a single original document face down and closed the scanner lid.
3. Press **OK** and enter the number of copies using the left/right arrow or numeric keypad.
4. Press **Menu** (☰) on the control panel.
5. Press the left/right arrow until **Copy Setup** appears and press **OK**.
6. Press the left/right arrow until **Change Default** appears and press **OK**.
7. Press the left/right arrow until **Copy Collation** appears and press **OK**.
8. Press the left/right arrow until **On** appears and press **OK**.

- **On:** Prints output in sets to match the sequence of originals.

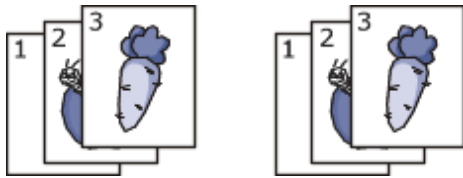

- **Off:** Prints output sorted into stacks of individual pages.

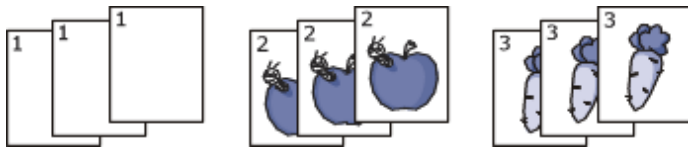

9. Press **Stop/Clear** (⏹) to return to ready mode.

10. Press **Start** to begin copying.

One complete document will print followed by the second complete document.

Setting copy timeout

You can set the time the machine waits before it restores the default copy settings, if you do not start copying after changing them on the control panel.

1. Press **Menu** (☰) on the control panel.
2. Press the left/right arrow until **System Setup** appears and press **OK**.
3. Press the left/right arrow until **Machine Setup** appears and press **OK**.
4. Press the left/right arrow until **Timeout** appears and press **OK**.
5. Press the left/right arrow until the time setting you want appears.

Selecting **Off** means that the machine does not restore the default settings until you press **Start** to begin copying, or **Stop/Clear** (⏹) to cancel.

6. Press **OK** to save the selection.

7. Press **Stop/Clear** (⏹) to return to ready mode.

Scanning

Scanning with your machine lets you turn pictures and text into digital files that can be stored on your computer.

This chapter includes:

- [Basic scanning method](#)
- [Scanning originals and sending to your computer \(Scan to PC\)](#)
- [Using Dell Scan and Fax Manager](#)
- [Scanning with TWAIN-enabled software](#)
- [Scanning using the WIA driver](#)
- [Macintosh scanning](#)
- [Linux Scanning](#)

 The maximum resolution that can be achieved depends upon various factors, including computer speed, available disk space, memory, the size of the image being scanned, and bit depth settings. Thus, depending on your system and what you are scanning, you may not be able to scan at certain resolutions, especially using enhanced resolution.

Basic scanning method

You can scan the originals with your machine via an USB cable or the network.

- **Dell Scan and Fax Manager:** Scan the originals from the control panel. Then, the scanned data will be stored in the connected computers **My Documents** folder. When you install all the software in the supplied CD, the Dell Scan and Fax Manager is also automatically installed on your computer. This feature can be used via the local connection or the network connection (See [Using Dell Scan and Fax Manager](#)).
- **TWAIN:** TWAIN is the one of a preset imaging applications. Scanning an image launches the selected application, enabling you to control the scanning process. This feature can be used via the local connection or the network connection (See [Scanning with TWAIN-enabled software](#)).
- **SmarThru:** This program is the accompanying software for your machine. You can use this program to scan images or documents. This feature can be used via the local connection or the network connection (See [Smarthru](#)).
- **WIA:** WIA stands for Windows Images Acquisition. To use this feature, your computer must be connected directly with the machine via an USB cable (See [Scanning using the WIA driver](#)).

Scanning originals and sending to your computer (Scan to PC)

You can scan an image on the machine via the Dell Scan and Fax Manager program that is installed in your networked computer.

For USB connected machine

This is a basic scanning method for USB connected machine.

1. Make sure that the machine is connected to your computer and powered on.
2. Load originals face up into the document feeder, or place a single original face down on the scanner glass.
(See [Loading originals](#)).
3. Press **Scan** () on the control panel.
4. Press the left/right arrow until **Scan To PC** appears and press **OK**.
5. Press the left/right arrow until **Local PC** appears and press **OK**.

 If you see **Not Available** message, check the port connection.

6. Press the left/right arrow until the application program you want appears and press **OK**.

Default setting is **My Documents**.

 To add or delete the folder where the scanned file is saved, add or delete the application program in **Dell Scan and Fax Manager > Properties > Set Scan Button**.

7. Press the left/right arrow until the setting you want appears and press **OK**.

- **Resolution**: Sets the image resolution.
- **Scan Color**: Sets the color mode.
- **Scan Format**: Sets the file format in which the image is to be saved.
- **Scan Size**: Sets the image size.

-  • **Scan Format** appears only when you selected the Scan destination to **My Documents**.
- If you want to scan from the default setting, press **Start**.

8. Scanning begins.

-  • Scanned image is saved in computer's **My Documents > My Pictures > Dell** folder.
- You can use Twain driver to scan quickly in **Dell Scan and Fax Manager** program.
- You can also scan by pressing Window's **Start > Control Panel > Dell Scan and Fax Manager > Quick Scan**.

For network connected machine

Make sure the printer driver is installed on your computer using the software CD, since the printer driver includes the scan program (See [Installing network connected machine's driver](#)).

1. Make sure that your machine and the computer are connected to a network and Dell Scan and Fax Manager is installed on the computer.
2. Load originals face up into the document feeder, or place a single original face down on the scanner glass.
3. Press **Scan** () on the control panel.
4. Press the left/right arrow until **Scan To PC** appears and press **OK**.
5. Press the left/right arrow until **Network PC** appears and press **OK**.

-  If you see **Not Available** message, check the port connection.

6. Select your registered computer **ID**, and enter the **Password** if necessary.

-  • **ID** is the same ID as the registered **Computer ID** for **Dell Scan and Fax Manager**.
- **Password** is the 4 digit number registered **Password** for **Dell Scan and Fax Manager**.

7. Press the left/right arrow until the application program you want appears and press **OK**.

Default setting is **My Documents**.

-  To add or delete the folder where the scanned file is saved, add or delete the application program in **Dell Scan and Fax Manager > Properties > Set Scan Button**.

8. Press the left/right arrow until the setting you want appears and press **OK**.

- **Resolution**: Sets the image resolution.
- **Scan Color**: Sets the color mode.
- **Scan Format**: Sets the file format in which the image is to be saved.
- **Scan Size**: Sets the image size.

-  • **Scan Format** appears only when you selected the Scan destination to **My Documents**.
- If you want to scan from the default setting, press **Start**.

9. Scanning begins.

-  • Scanned image is saved in computer's **My Documents > My Pictures > Dell** folder.
- You can use Twain driver to scan quickly in **Dell Scan and Fax Manager** program.
- You can also scan by pressing Window's **Start > Control Panel > Dell Scan and Fax Manager > Quick Scan**.

Using Dell Scan and Fax Manager

If you have installed the printer driver, the Dell Scan and Fax Manager program is installed too. Start Dell Scan and Fax Manager program to find out about this program information and the installed scan driver's condition. Through this program, you can change scan settings and add or delete the folders where scanned documents are saved in your computer.

 The Dell Scan and Fax Manager program can only be used in the Windows.

1. From the **Start** menu, click **Control Panel > Dell Scan and Fax Manager**.
2. Select the appropriate machine from the Dell Scan and Fax Manager window.
3. Press **Properties**.

4. The **Set Scan Button** tab allows you to change the saving destination and scan settings, add or delete application program, and format files.

You can change the scanning machine by using the **Change Port** tab (Local or Network).

5. When setting is done, press **OK**.

Set Scan Button tab

Scan Destination

- **Available Destination List:** Shows the list of applications currently linked to scanned images in the PC's registry. Select the program you want to use and click the right arrow and add to **Front Panel Destination List**.
- **Front Panel Destination List:** Shows the list of applications to open scanned image.
- **Add Application:** Allows you to add application you want to use to **Available Destination List**,
- **Remove Application:** Allows you to remove an item added by the user in the **Available Destination List**.
- **File Format:** Allows you to select the form of scanned data to be saved. You can choose among **BMP, JPEG, PDF, and TIFF**.

Scan Property

- **Computer ID:** Shows the ID of your computer.
- **Save Location:** Allows you to choose the location of the default saving folder.
- **Resolution:** Allows you to choose the scan resolution.
- **Scan Color:** Allows you to choose the scan color.
- **Scan Size:** Allows you to choose the scan size.
- **ADF Duplex:** Automatically scans both sides. If your model does not support this option, it will be grayed out.
- **Show Preview:** Checking this box allows you to preview applied scan options. You can modify the options before scanning.
- **Default:** Allows you to go back to default options.

Change Port tab

Local Scanner

Select when your machine is connected via USB or LPT port.

Network Scanner

Select when your machine is connected via network port.

- **Auto detection on the network:** Automatically detects your machine.
- **IP address:** Enter in your machine's IP address to detect your machine.

Scanning with TWAIN-enabled software

If you want to scan documents using other software, you will need to use TWAIN-compliant software, such as Adobe Photoshop.

Follow the steps below to scan with TWAIN-compliant software:

1. Make sure that the machine is connected to your computer and powered on.
2. Load originals face up into the document feeder, or place a single original face down on the scanner glass. (See [Loading originals](#)).
3. Open an application, such as Adobe Photoshop.
4. Open the TWAIN window and set the scan options.
5. Scan and save your scanned image.

Scanning using the WIA driver

Your machine also supports the Windows Image Acquisition (WIA) driver for scanning images. WIA is one of the standard components provided by Microsoft Windows XP and works with digital cameras and scanners. Unlike the TWAIN driver, the WIA driver allows you to scan and easily adjust images without using additional software.



 The WIA driver works only on Windows XP/Vista with a USB port.

Windows XP

1. Make sure that the machine is connected to your computer and powered on.

2. Load originals face up into the document feeder, or place a single original face down on the scanner glass. (See [Loading originals](#)).
3. From the **Start** menu, select **Control Panel**, > **Scanners and Cameras**.
4. Double click your scanner driver icon. The **Scanner and Camera wizard** appears.
5. Click **Next**.
6. Set the option in **Choose scanning preferences** window and click **Preview** to see how your options affect the picture.
7. Click **Next**.
8. Enter a picture name, and select a file format and destination to save the picture.
9. Your picture has been successfully copied to your computer. Choose one of the options on screen.
10. Click **Next**.
11. Click **Finish**.

Windows Vista

1. Make sure that the machine is connected to your computer and powered on.
 2. Load originals face up into the document feeder, or place a single original face down on the scanner glass. (See [Loading originals](#)).
 3. From the **Start** menu select **Control Panel** > **Hardware and Sound** > **Scanners and Cameras**.
 4. Double click **Scan a document or picture**. **Windows Fax and Scan** application appears.
 -  • You can click on **View scanners and cameras** to view scanners,
 - If there is no **Scan a document or picture**, open the MS paint program and from the **File** click **From Scanner or Camera...**
 5. Click **New Scan**. Scan driver appears.
 6. Choose your scanning preferences and click **Preview** to see your preferences affect the picture.
 7. Click **Scan**.
-  If you want to cancel the scan job, press the **Cancel** button on the **Scanner and Camera wizard**.



Windows 7

1. Make sure that the machine is connected to your computer and powered on.
2. Load originals face up into the document feeder, or place a single original face down on the scanner glass (See [Loading originals](#)).
3. From the **Start** menu select **Control Panel** > **Hardware and Sound** > **Devices and Printers**.
4. Click right button of mouse on device driver icon in **Printers and Faxes** > **Start Scan**. **New Scan** application appears.
5. Choose your scanning preferences and click **Preview** to see your preferences affect the picture.
6. Click **Scan**.

Macintosh scanning

Scanning with Image Capture

You can scan documents using **Image Capture** program. Macintosh OS offers **Image Capture** program.

1. Make sure that your machine and computer are turned on and properly connected to each other.
 2. Load originals face up into the document feeder, or place a single original face down on the scanner glass. (See [Loading originals](#)).
 3. Start **Applications** and click **Image Capture**.
 -  If **No Image Capture device connected** message appears, disconnect the USB cable and reconnect it. If the problem continues, refer to the **Image Capture's** help.
 4. Set the scan options on this program.
 5. Scan and save your scanned image.
-  • For more information about using **Image Capture**, refer to the **Image Capture's** help.
- Scan process differ according to TWAIN-compliant software. Please refer to the user's guide of the software.
 - When scanning does not operate, update Mac OS to the latest version. Scanning operates properly in Mac OS 10.4.7 or higher.
 - Use TWAIN-compliant softwares to apply more scan options.

- You can also scan using TWAIN-compliant softwares, such as Adobe Photoshop.
- Scanning using network can be performed via only TWAIN UI.

Scanning with Twain-Enabled software

If you want to scan documents using other software, you will need to use TWAIN-compliant software, such as Adobe Photoshop. Follow the steps below to scan with TWAIN-compliant software:

1. Make sure that your machine and computer are turned on and properly connected to each other.
2. Load originals face up into the document feeder, or place a single original face down on the scanner glass.
(See [Loading originals](#)).
3. Open an application, such as Adobe Photoshop.
4. Open the TWAIN window and set the scan options.
5. Scan and save your scanned image.

 For scanning with network:

- If a warning message appears, click **Change Port..** to select port.
- If TWAIN UI appears, from the **Preference** tab, click **Change Port..** to select port.
- You can change the scanning machine by using the **Change Port..** (Local or Network).

Linux Scanning

You can scan a document using the Unified Driver Configurator window.

Scanning

1. Double-click the **Unified Driver Configurator** on your desktop.
2. Click the  button to switch to Scanners configuration.
3. Select the scanner on the list.

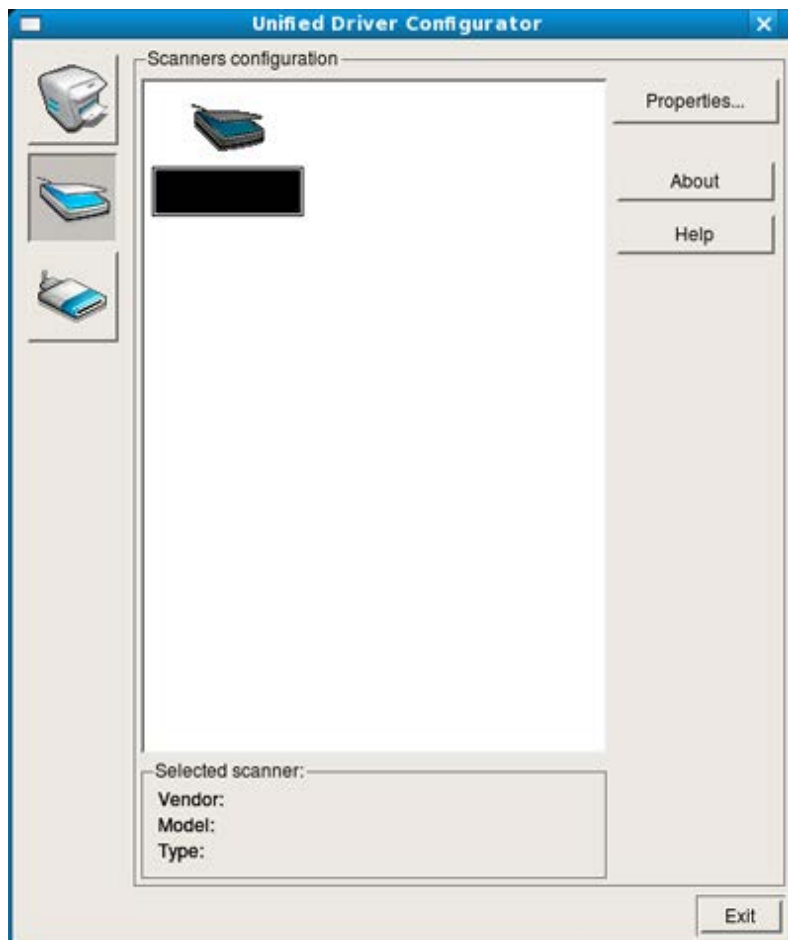

If you use only one machine device and it is connected to the computer and turned on, your scanner appears on the list and is automatically selected.

If you have two or more scanners connected to your computer, you can select any scanner to work at any time. For example, while acquisition is in progress on the first scanner, you may select the second scanner, set the device options and start the image acquisition simultaneously.

4. Click **Properties**.
5. Load originals face up into the document feeder, or place a single original face down on the scanner glass. (See [Loading originals](#)).
6. From the **Scanner Properties** window, click **Preview**.
The document is scanned and the image preview appears in the **Preview Pane**.

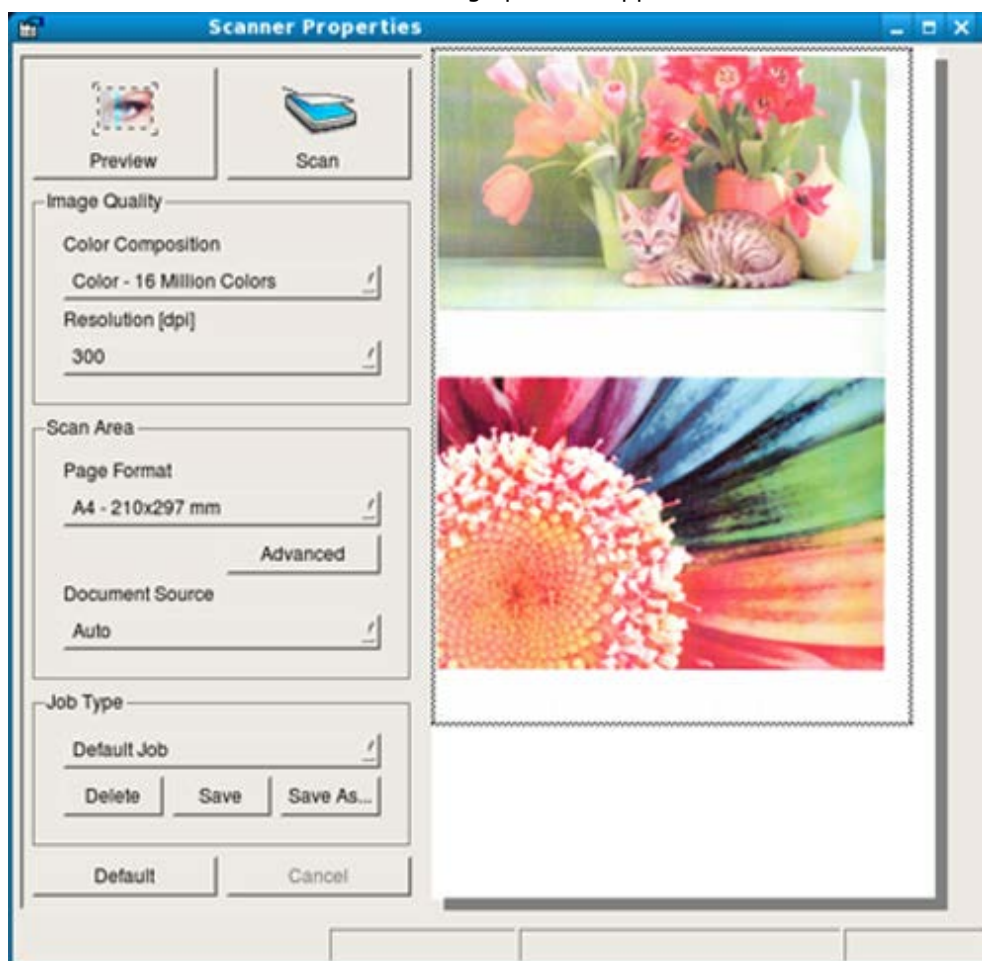

7. Drag the pointer to set the image area to be scanned in the **Preview Pane**.
 8. Change the scan options in the **Image Quality** and **Scan Area** sections.
 - **Image Quality**: This option allows you to select the color composition and the scan resolution for the image.
 - **Scan Area**: This option allows you to select the page size. The **Advanced** button enables you to set the page size manually.
- If you want to use one of the preset scan option settings, select the option from the **Job Type** drop-down list (See [Adding Job Type Settings](#)).
- Click **Default** to restore the default setting for the scan options.
9. When you have finished, click **Scan** to start scanning.
The status bar appears on the bottom left of the window to show you the progress of the scan. To cancel scanning, click **Cancel**.
 10. The scanned image appears.
If you want to edit the scanned image, use the toolbar (See [Using the Image Manager](#)).
 11. When you are finished, click **Save** on the toolbar.
 12. Select the file directory where you want to save the image and enter the file name.
 13. Click **Save**.

Adding Job Type Settings

You can save your scan option settings for later use.

To save a new Job Type setting:

1. Change the options from the Scanner Properties window.
2. Click **Save As**.
3. Enter the name for your setting.

4. Click **OK**.

Your setting is added to the **Saved Settings** drop-down list.

To save a Job Type setting for the next scan job:

1. Select the setting you want to use from the **Job Type** drop-down list.
2. The next time you open the **Scanner Properties** window, the saved setting is automatically selected for the scan job.

To delete a Job Type setting

1. Select the setting you want to delete from the **Job Type** drop-down list.
2. Click **Delete**.







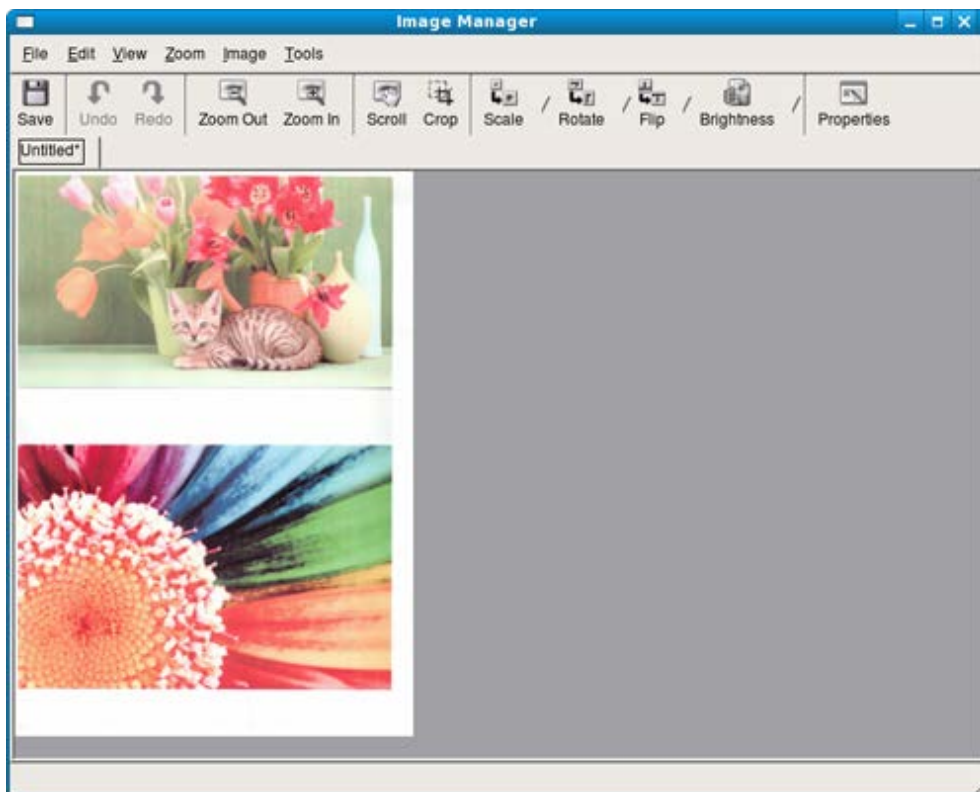



The setting is deleted from the list.

Using the Image Manager

The Image Manager application provides you with menu commands and tools to edit your scanned image.



Use the following tools to edit the image:

Tools	Name	Function
	Save	Saves the image.
	Undo	Cancels your last action.
	Redo	Restores the action you canceled.
	Scroll	Allows you to scroll through the image.
	Crop	Crops the selected image area.
	Zoom Out	Zooms the image out.
	Zoom In	Zooms the image in.
	Scale	Allows you to scale the image size; you can enter the size manually, or set the rate to scale proportionally, vertically, or horizontally.
	Rotate	Allows you to rotate the image; you can select the number of degrees from the drop-down list.
	Flip	Allows you to flip the image vertically or horizontally.
	Brightness	Allows you to adjust the brightness or contrast of the image, or to invert the image.



Properties Shows the properties of the image.

For further details about the Image Manager application, refer to the on screen help.

Faxing

This chapter gives you information about using your machine as a fax machine.

This chapter includes:

- [Preparing to fax](#)
- [Using a fax in your computer](#)
- [Sending a fax in your machine](#)
- [Receiving a fax in your machine](#)
- [Adjusting the document settings](#)
- [Forwarding a fax to another destination](#)
- [Setting up address book](#)
- [Printing sent fax report automatically](#)



- You cannot use this machine as a fax via the internet phone. For more information ask your internet service provider.
- We recommend using traditional analog phone services (PSTN: public switched telephone network) when connecting telephone lines to use the Fax. If you use other Internet services (DSL, ISDN, VoIP), you can improve the connection quality by using the Micro-filter. The Micro-filter eliminates unnecessary noise signals and improves connection quality or Internet quality. Since the DSL Micro-filter is not provided with the machine, contact your Internet Service provider for use on DSL Micro-filter.

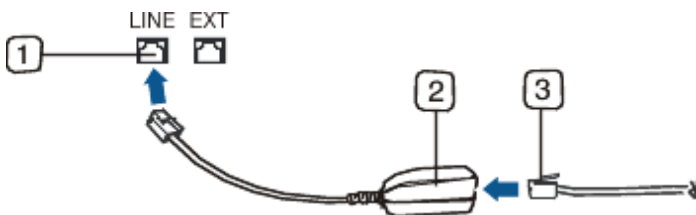

1. Line port
2. Micro filter
3. DSL modem / Telephone line



Supported optional devices and features may differ according to your model. Please check your model name. (See [Features by Model](#)).

Preparing to fax

Before you send or receive a fax, you need to connect the supplied line cord to the wall jack. Refer to the Quick Install Guide how to make a connection. The method of making a telephone connection is varies from one country to another.



Using a fax in your computer

You can receive a fax from your computer without going to the machine.

Receiving a fax

If you have installed the printer driver, the Dell Scan and Fax Manager program is also installed. Start Dell Scan and Fax Manager program to find out about this program information and the installed driver's condition. Through this program, you can change fax settings and add or delete the folders where faxed documents are saved in your computer.

 Dell Scan and Fax Manager program can only be used with the Windows systems. Check if the forwarding a fax to PC is set to **On**:

1. Press **Fax** () on the control panel.
2. Press **Menu** () on the control panel.
3. Press the left/right arrow until **Fax Feature** appears and press **OK**.
4. Press the left/right arrow until **Forward** appears and press **OK**.
5. Press the left/right arrow until **PC** appears and press **OK**.

1. Make sure that the machine is connected to your computer and powered on.
2. Open **Dell Scan and Fax Manager**.
From the **Start** menu, click **Control Panel > Dell Scan and Fax Manager**.
3. Select the appropriate machine from **Dell Scan and Fax Manager** and click **Properties**.
4. Move to the **Set Fax Receiving** tab and activate **Enable Fax Receiving**.

 This feature can be used by only one user at a time because the fax may have confidential or private information. If fax receiving is set to another user and you attempt to enable it, a pop-up window will appear. Try again when fax receiving is not being used by another user. You can set the following options through the **Set Fax Receiving** tab:

- **Enable Fax Receiving:** You can select whether to use or not.
- **File Format:** You can convert the received faxes to PDF or TIFF.
- **Save Location:** Selects location to save the converted faxes.
- **Prefix:** Selects file or folder scheme as prefix.
- **Notify me when fax received:** Shows popup window to notify receiving a fax.
- **Print received fax:** After receiving the fax, set prints information for the received fax.

5. When setting is done, press **OK**.



Sending a fax in your machine

This part explains how to send a fax and the special methods of transmission.



 When you place the originals, you can use either the document feeder or the scanner glass (See [Loading originals](#)). If the originals are placed on both the document feeder and the scanner glass, the machine will read the originals on the document feeder first, which has higher priority in scanning.



Setting the fax header

In some countries, you are required by law to indicate your fax number on any fax you send.

1. Press **Menu** () on the control panel.
2. Press the left/right arrow until **System Setup** appears and press **OK**.
3. Press the left/right arrow until **Machine Setup** appears and press **OK**.
4. Press the left/right arrow until **Machine ID** appears and press **OK**.
5. Enter your name or the company name using the number keypad. You can enter alphanumeric characters using the number keypad, and include special symbols by pressing the 1 button. For details on how to enter alphanumeric characters, see [Entering characters using the number keypad](#).
6. Press **OK** to save the ID.
7. Press the left/right arrow until **Machine Fax No.** appears and press **OK**.
8. Enter your fax number using the number keypad and press **OK**.
9. Press **Stop/Clear** () to return to ready mode.

Sending a fax



1. Press **Fax** () on the control panel.
2. Load originals face up into the document feeder, or place a single original face down on the scanner glass. (See [On the scanner glass](#) or [In the document feeder](#)).
3. Adjust the resolution and the darkness to suit your fax needs (See [Adjusting the document settings](#)).
4. Enter the receiving fax machine's number.
You can use speed dial numbers, or group dial numbers. For details about storing and searching for a number, see [Setting up address book](#).
5. Press **Start** () on the control panel. The machine starts to scan and send a fax to destinations.

-  • When you want to cancel a fax job, press **Stop/Clear** () before the machine start transmission.
- If you used the scanner glass, the machine shows the message asking to place another page.

Sending a fax manually

This method is sending a fax using **On Hook Dial** on the control panel.

1. Press **Fax** () on the control panel.
2. Load originals face up into the document feeder, or place a single original face down on the scanner glass.
3. Adjust the resolution and the darkness to suit your fax needs (See [Adjusting the document settings](#)).

4. Press **On Hook Dial** () on the control panel or lift the handset.
 5. Enter a fax number using the number keypad on the control panel.
 6. Press **Start** when you hear a high-pitched fax signal from the remote fax machine.
-  When you want to cancel a fax job, press **Stop/Clear** () at any time while sending.

Confirming a transmission

When the last page of your original has been sent successfully, the machine beeps and returns to ready mode. When something goes wrong while sending your fax, an error message appears on the display. For a list of error messages and their meanings, see [Understanding display messages](#). If you receive an error message, press **Stop/Clear** () to clear the message and try to send the fax again.

You can set your machine to print a confirmation report automatically each time sending a fax is completed. For further details, see [Printing sent fax report automatically](#).

Automatic redialing

When the number you have dialed is busy or there is no answer when you send a fax, the machine automatically redials the number every three minutes, up to seven times according to the factory default settings.

When the display shows **Retry Redial?**, press **OK** to redial the number without waiting. To cancel the automatic redialing, press **Stop/Clear** ()

To change the time interval between redials and the number of redial attempts (See [Changing the fax setup options](#)).



Redialing the last number

To redial the number you called last:

1. Press **Redial/Pause** () on the control panel.
2. When an original is loaded in the document feeder, the machine automatically begins to send.
If an original is placed on the scanner glass, select **Yes** to add another page. Load another original and press **OK**.
When you have finished, select **No** at the **Another Page?** prompt.

Sending a fax to multiple destinations



You can use the Multiple Send feature, which allows you to send a fax to multiple locations. Originals are automatically stored in memory and sent to a remote station. After transmission, the originals are automatically erased from memory. You cannot send a color fax using this feature.

1. Press **Fax** () on the control panel.
2. Load originals face up into the document feeder, or place a single original face down on the scanner glass.
3. Adjust the resolution and the darkness to suit your fax needs (See [Adjusting the document settings](#)).
4. Press **Menu** () on the control panel.
5. Press the left/right arrow until **Fax Feature** appears and press **OK**.
6. Press the left/right arrow until **Multi Send** appears and press **OK**.
7. Enter the number of the first receiving fax machine and press **OK**.
You can press speed dial numbers or select group dial number using **Address book** button. For details, see [Setting up address book](#).
8. Enter the second fax number and press **OK**.
The display asks you to enter another fax number to send the document.
9. To enter more fax numbers, press **OK** when **Yes** appears and repeat steps 7 and 8. You can add up to 10 destinations.
10. Press **OK** to start storing the scanned original data into memory.
 Once you entered a group dial number, you cannot enter another group dial numbers anymore.
11. When you have finished entering fax numbers, press the left/right arrow to select **No** at the **Another No.?** prompt and press **OK**.
12. If an original is placed on the scanner glass, select **Yes** to add another pages. Load another original and press **OK**.
When you have finished, select **No** at the **Another Page?** prompt.
The machine begins sending the fax to the numbers you entered in the order in which you entered them.

Delaying a fax transmission



You can set your machine to send a fax at a later time when you will not be present. You cannot send a color fax using this feature.

1. Press **Fax** () on the control panel.

2. Load originals face up into the document feeder, or place a single original face down on the scanner glass.
3. Adjust the resolution and the darkness to suit your fax needs (See [Adjusting the document settings](#)).
4. Press **Menu** () on the control panel.
5. Press the left/right arrow until **Fax Feature** appears and press **OK**.
6. Press the left/right arrow until **Delay Send** appears and press **OK**.
7. Enter the number of the receiving fax machine and press **OK**.
You can press speed dial numbers or select group dial number using **Address book** button. For details, see [Setting up address book](#).
8. The display asks you to enter another fax number to send the document.
9. To enter more fax numbers, press **OK** when **Yes** appears and repeat steps 7. You can add up to 10 destinations.
 Once you entered a group dial number, you cannot enter another group dial numbers anymore.
10. When you have finished entering fax numbers, press the left/right arrow to select **No** at the **Another No.?** prompt and press **OK**.
11. Enter the job name you want and press **OK**.
For details on how to enter alphanumeric characters, see [Entering characters using the number keypad](#).
If you do not want to assign a name, skip this step.
12. Enter the time using the number keypad and press **OK**.
 If you set a time earlier than the current time, the fax will be sent at that time on the following day.
The original is scanned into memory before transmission.
13. If an original is placed on the scanner glass, select **Yes** to add another pages. Load another original and press **OK**.
When you have finished, select **No** at the **Another Page?** prompt.
The machine returns to ready mode. The display reminds you that you are in ready mode and that a delayed fax is set.



Adding documents to a reserved delay fax job

You can add additional documents to the delayed fax job which is saved in memory.

1. Load the originals to be added and adjust document settings.
2. Press **Menu** () on the control panel.
3. Press the left/right arrow until **Fax Feature** appears and press **OK**.
4. Press the left/right arrow until **Add pages** appears and press **OK**.
5. Press the left/right arrow until the fax job you want appears and press **OK**.
When you have finished, select **No** at the **Another Page?** prompt. The machine scans the original into memory.
6. Press **Stop/Clear** () to return to ready mode.



Canceling a reserved delay fax job

You can cancel the delayed fax job which is saved in memory.

1. Press **Menu** () on the control panel.
2. Press the left/right arrow until **Fax Feature** appears and press **OK**.
3. Press the left/right arrow until **Cancel Job** appears and press **OK**.
4. Press the left/right arrow until the fax job you want appears and press **OK**.
5. Press **OK** when **Yes** appears.
The selected fax is deleted from memory.
6. Press **Stop/Clear** () to return to ready mode.

Sending a priority fax

This function is used when a high priority fax need to be sent ahead of reserved operations. The original is scanned into memory and immediately transmitted when the current operation is finished. In addition, priority transmission will interrupt a sending to multiple destinations between stations (example, when the transmission to station A ends, before transmission to station B begins) or between redial attempts.

1. Press **Fax** () on the control panel.
2. Load originals face up into the document feeder, or place a single original face down on the scanner glass.
3. Adjust the resolution and the darkness to suit your fax needs (See [Adjusting the document settings](#)).
4. Press **Menu** () on the control panel.



5. Press the left/right arrow until **Fax Feature** appears and press **OK**.
6. Press the left/right arrow until **Priority Send** appears and press **OK**.
7. Enter the number of the receiving fax machine and press **OK**.
You can press speed dial numbers or select group dial number using **Address book** button. For details, see [Setting up address book](#).
8. Enter the job name you want and press **OK**.
The original is scanned into memory before transmission.
9. If an original is placed on the scanner glass, select **Yes** to add another pages. Load another original and press **OK**.
When you have finished, select **No** at the **Another Page?** prompt.
The machine starts to scan and send a fax to destinations.

Receiving a fax in your machine

This part explains how to receive a fax, and the special receiving methods available.

Changing the receive modes

Your machine is preset to **Fax** mode at the factory. When you receive a fax, the machine answers the call on a specified number of rings and automatically receives the fax. But if you want to change the Fax mode to another mode, follow the steps below:

1. Press **Fax** () on the control panel.
2. Press **Menu** () on the control panel.
3. Press the left/right arrow until **Fax Setup** appears and press **OK**.
4. Press the left/right arrow until **Receiving** appears and press **OK**.
5. Press the left/right arrow until **Receive Mode** appears and press **OK**.
6. Press the left/right arrow until the fax reception mode you want appears.
 - **Fax**: Answers an incoming fax call and immediately goes into the fax reception mode.
 - **Tel**: Receives a fax by pressing **On Hook Dial** and then **Start**. If your machine has a handset, you can receive a fax by picking up the handset.
 - **Ans/Fax**: Is for when an answering machine attached to your machine. Your machine answers an incoming call, and the caller can leave a message on the answering machine. If the fax machine senses a fax tone on the line, the machine automatically switches to Fax mode to receive the fax.
 - **DRPD**: you can receive a call using the Distinctive Ring Pattern Detection (DRPD) feature. Distinctive Ring is a telephone company service which enables an user to use a single telephone line to answer several different telephone numbers. For further details, see [Receiving faxes using DRPD mode](#).
7. Press **OK** to save your selection.
8. Press **Stop/Clear** () to return to ready mode.
 - To use the **Ans/Fax** mode, attach an answering machine to the EXT socket on the back of your machine.
 - If you do not want other people to view your received documents, you can use secure receiving mode. In this mode, all of the received faxes are stored in memory. For further details, see [Receiving in secure receiving mode](#).

Receiving manually in Tel mode

You can receive a fax call by pressing **On Hook Dial** and then pressing **Start** when you hear a fax tone from the remote machine. The machine begins receiving a fax. If your machine has a handset, you can answer calls using the handset.

To change the number of rings, see [Changing the fax setup options](#).

Receiving automatically in Answering Machine/Fax mode

To use this mode, you must attach an answering machine to the EXT socket on the back of your machine (See [Rear view](#)).

If the caller leaves a message, the answering machine stores the message as it would normally. If your machine detects a fax tone on the line, it automatically starts to receive the fax.

- If you have set your machine to this mode and your answering machine is switched off, or no answering machine is connected to EXT socket, your machine automatically goes into Fax mode after a predefined number of rings.
- If your answering machine has a user-selectable ring counter, set the machine to answer incoming calls within 1 ring.

- If you are in Tel mode when the answering machine is connected to your machine, you must switch off the answering machine. otherwise, the outgoing message from the answering machine will interrupt your phone conversation.

Receiving faxes manually using an extension telephone

This feature works best when you are using an extension telephone connected to the EXT socket on the back of your machine. You can receive a fax from someone you are talking to on the extension telephone, without going to the fax machine.

When you receive a call on the extension phone and hear fax tones, press the keys *9* on the extension phone. The machine receives the fax.

Press the buttons slowly in sequence. If you still hear the fax tone from the remote machine, try pressing *9* once again.

9 is the remote receive code preset at the factory. The first and the last asterisks are fixed, but you can change the middle number to whatever you wish. For details about changing the code, see [Changing the fax setup options](#)

Receiving faxes using DRPD mode

Distinctive Ring is a telephone company service which enables an user to use a single telephone line to answer several different telephone numbers. The particular number someone uses to call you is identified by different ringing patterns, which consist of various combinations of long and short ringing sounds. This feature is often used by answering services who answer telephones for many different clients and need to know which number someone is calling in on to properly answer the phone.

Using the Distinctive Ring Pattern Detection (DRPD) feature, your fax machine can learn the ring pattern you designate to be answered. Unless you change it, this ringing pattern will continue to be recognized and answered as a fax call, and all other ringing patterns will be forwarded to the extension telephone or answering machine plugged into the EXT socket. You can easily suspend or change DRPD at any time.

Before using the DRPD option, Distinctive Ring service must be installed on your telephone line by the telephone company. To set up DRPD, you will need another telephone line at your location, or someone available to dial your fax number from outside.

To set up the DRPD mode:

1. Press **Fax** (📠) on the control panel.
2. Press **Menu** (☰) on the control panel.
3. Press the left/right arrow until **Fax Setup** appears and press **OK**.
4. Press the left/right arrow until **Receiving** appears and press **OK**.
5. Press the left/right arrow until **Receive Mode** appears and press **OK**.
6. Press the left/right arrow until **DRPD** appears and press **OK**.
Waiting Ring appears on the display.
7. Call your fax number from another telephone. It is not necessary to place the call from a fax machine.
8. When your machine begins to ring, do not answer the call. The machine requires several rings to learn the pattern.
When the machine completes learning, the display shows **Completed DRPD Setup**. If the DRPD setup fails, **Error DRPD Ring** appears.
Press OK when DRPD appears and start over from step 6.

- DRPD must be set up again if you re-assign your fax number, or connect the machine to another telephone line.
- After DRPD has been set up, call your fax number again to verify that the machine answers with a fax tone. Then have a call placed to a different number assigned to that same line to be sure the call is forwarded to the extension telephone or answering machine plugged into the EXT socket.

Receiving in secure receiving mode

You may need to prevent your received faxes from being accessed by unauthorized people. You can turn on secure receiving mode to restrict printing of received faxes when the machine is unattended. In secure receiving mode, all incoming faxes go into memory. When the mode is deactivated, any stored faxes are printed.

Activating secure receiving mode

1. Press **Fax** (📠) on the control panel.
2. Press **Menu** (☰) on the control panel.
3. Press the left/right arrow until **Fax Feature** appears and press **OK**.
4. Press the left/right arrow until **Secure Receive** appears and press **OK**.
5. Press the left/right arrow until **On** appears and press **OK**.
6. Enter a four-digit password you want to use and press **OK**.

 You can activate secure receiving mode without setting a password, but cannot protect your faxes.

7. Re-enter the password to confirm it and press **OK**.

8. Press **Stop/Clear** () to return to ready mode.

When a fax is received in secure receiving mode, your machine stores it in memory and shows **Secure Receive** to let you know that there is a fax received.

Printing received faxes

1. Access the **Secure Receive** menu by following steps 1 through 4 in "Activating secure receiving mode."
2. Press the left/right arrow until **Print** appears and press **OK**.
3. Enter the four-digit password and press **OK**.

The machine prints all of the faxes stored in memory.

Deactivating secure receiving mode

1. Access the **Secure Receive** menu by following steps 1 through 4 in "Activating secure receiving mode."
2. Press the left/right arrow until **Off** appears and press **OK**.
3. Enter the four-digit password and press **OK**.

The mode is deactivated and the machine prints all faxes stored in memory.

4. Press **Stop/Clear** () to return to ready mode.

Receiving faxes in memory



Since your machine is a multi-tasking device, it can receive faxes while you are making copies or printing. If you receive a fax while you are copying or printing, your machine stores incoming faxes in its memory. Then, as soon as you finish copying or printing, the machine automatically prints the fax.

Adjusting the document settings

Before starting a fax, change the following settings according to your original's status to get the best quality.

Resolution

The default document settings produces good results when using typical text-based originals. However, if you send originals that are of poor quality, or contain photographs, you can adjust the resolution to produce a higher quality fax.

1. Press **Fax** () on the control panel.
2. Press **Menu** () on the control panel.
3. Press the left/right arrow until **Fax Feature** appears and press **OK**.
4. Press the left/right arrow until **Resolution** appears and press **OK**.
5. Press the left/right arrow until the option you want appears and press **OK**.
6. Press **Stop/Clear** () to return to ready mode.

Recommended resolution settings for different original document types are described in the table below:

mode	recommended for:
Standard	Originals with normal sized characters.
Fine	Originals containing small characters or thin lines or originals printed using a dot-matrix printer.
Super Fine	Originals containing extremely fine detail. Super Fine mode is enabled only if the machine with which you are communicating also supports the Super Fine resolution.  <ul style="list-style-type: none">• For memory transmission, Super Fine mode is not available. The resolution setting is automatically changed to Fine• When your machine is set to Super Fine resolution and the fax machine with which you are communicating does not support Super Fine resolution, the machine transmits using the highest resolution mode supported by the other fax machine.
Photo Fax	Originals containing shades of gray or photographs.
Color Fax	Originals with colors. Sending a color fax is enabled only if the machine with which you are communicating supports color fax reception and you send the fax manually. In this mode, memory transmission is not available.

 The resolution setting is applied to the current fax job. To change the default setting, see [Change Default](#).

Darkness

You can select the degree of darkness of the original document.

1. Press **Fax** (📠) on the control panel.
2. Press **Menu** (☰) on the control panel.
3. Press the left/right arrow until **Fax Feature** appears and press **OK**.
4. Press the left/right arrow until **Darkness** appears and press **OK**.
5. Press the left/right arrow until the option you want appears and press **OK**.
6. Press **Stop/Clear** (⏹) to return to ready mode.

 The darkness setting is applied to the current fax job. To change the default setting, see [Change Default](#).

Forwarding a fax to another destination

You can set the machine to forward the received or sent fax to other destination by a fax. If you are out of office but have to receive the fax, this feature may be useful.

Forwarding a sent fax to another destination

You can set the machine to forward every fax you sent to another destination.

1. Press **Fax** (📠) on the control panel.
2. Press **Menu** (☰) on the control panel.
3. Press the left/right arrow until **Fax Feature** appears and press **OK**.
4. Press the left/right arrow until **Forward** appears and press **OK**.
5. Press the left/right arrow until **Fax** appears and press **OK**.
6. Press the left/right arrow until **Send Forward** appears and press **OK**.
7. Press the left/right arrow until **On** appears and press **OK**.
8. Enter the number of the fax machine to which faxes are to be sent and press **OK**.
9. Press **Stop/Clear** (⏹) to return to ready mode.

Subsequent sent faxes will be forwarded to the specified fax machine.

Forwarding a received fax to another destination

With this feature, you can forward every fax you received to another destination. When the machine receives a fax, a fax is stored in the memory then, the machine sends it to the destination you have set.

1. Press **Fax** (📠) on the control panel.
2. Press **Menu** (☰) on the control panel.
3. Press the left/right arrow until **Fax Feature** appears and press **OK**.
4. Press the left/right arrow until **Forward** appears and press **OK**.
5. Press the left/right arrow until **Fax** appears and press **OK**.
6. Press the left/right arrow until **Rcv. Forward** appears and press **OK**.
7. Press the left/right arrow until **Forward** appears and press **OK**.
8. Enter the number of the fax machine to which faxes are to be sent and press **OK**.
9. Enter the starting time using left/right arrow or numeric keypad and press **OK**.
10. Enter the ending time using left/right arrow or numeric keypad and press **OK**.
11. Press **Stop/Clear** (⏹) to return to ready mode.

Subsequent received faxes will be forwarded to the specified fax machine.

Setting up address book



You can set up **Address Book** with the fax numbers you use most frequently. Your machine provides you with the following features for setting up **Address Book**:

 Before beginning to store fax numbers, make sure that your machine is in Fax mode.



Speed dial numbers

You can store up to 200 frequently-used fax numbers in speed dial numbers.

Registering a speed dial number

1. Press **Fax** () on the control panel.
2. Press **Address Book** () on the control panel.
3. Press the left/right arrow until **New & Edit** appears and press **OK**.
4. Press the left/right arrow until **Speed Dial** appears and press **OK**.
5. Enter a speed dial number between 0 and 199 and press **OK**.
If an entry is already stored in the number you choose, the display shows the message to allow you to change it. To start over with another speed dial number, press **Back**.
6. Enter the name you want and press **OK**.
For details on how to enter alphanumeric characters (See [Entering characters using the number keypad](#)).
7. Enter the fax number you want and press **OK**.
8. Press **Stop/Clear** () to return to ready mode.

Editing speed dial numbers

1. Press **Fax** () on the control panel.
2. Press **Address Book** () on the control panel.
3. Press the left/right arrow until **New & Edit** appears and press **OK**.
4. Press the left/right arrow until **Speed Dial** appears and press **OK**.
5. Enter the speed dial number you want to edit and press **OK**.
6. Change the name and press **OK**.
7. Change the fax number and press **OK**.
8. Press **Stop/Clear** () to return to ready mode.

Using speed dial numbers

When you are prompted to enter a destination number while sending a fax, enter the speed dial number at which you stored the number you want.



- For a one-digit (0-9) speed dial number, press and hold the corresponding digit button on the number keypad.
- For a two- or three-digit speed dial number, press the first digit button(s) and then hold down the last digit button.

You can also search through memory for an entry by pressing Address Book (See [Searching Address Book for an entry](#)).



Group dial numbers

If you frequently send the same document to several destinations, you can group these destinations and set them under a group dial number. You can then use a group dial number to send a document to all of the destinations within the group. You can set up to 100 (0 through 99) group dial numbers using the destination's existing speed dial numbers.

Registering a group dial number

1. Press **Fax** () on the control panel.
2. Press **Address Book** () on the control panel.
3. Press the left/right arrow until **New & Edit** appears and press **OK**.
4. Press the left/right arrow until **Group Dial** appears and press **OK**.
5. Enter a group dial number between 0 and 99 and press **OK**.
If an entry is already stored in the number you choose, the display shows the message to allow you to change it.
6. Enter the name you want and press **OK**.
For details on how to enter alphanumeric characters (See [Entering characters using the number keypad](#)).
7. Enter the first few letters of the speed dial's name you want.
8. Press the left/right arrow until the name and number you want appears and press **OK**.
9. Press **OK** when **Yes** appears at the **Another No.?** prompt.
Repeat step 7 to include other speed dial numbers into the group.
10. When you have finished, press the left/right arrow to select **No** at the **Another No.?** prompt and press **OK**.
11. Press **Stop/Clear** () to return to ready mode.

Editing a group dial number

1. Press **Fax** () on the control panel.
2. Press **Address Book** () on the control panel.
3. Press the left/right arrow until **New & Edit** appears and press **OK**.
4. Press the left/right arrow until **Group Dial** appears and press **OK**.
5. Enter the group dial number you want to edit and press **OK**.
6. Enter the name you want to edit and press **OK**.
7. Enter the first few letters of the speed dial's name you want to add or delete.
8. Press the left/right arrow until the name and number you want appears and press **OK**.
If you entered a new speed dial number, **Add?** appears.
If you enter a speed dial number stored in the group, **Delete?** appears.
9. Press **OK** to add or delete the number.
10. Press **OK** when **Yes** appears to add or delete more numbers and repeat steps 7 and 8.
11. When you have finished, press the left/right arrow to select **No** at the **Another No.?** and press **OK**.
12. Press **Stop/Clear** () to return to ready mode.

Using group dial numbers



To use a group dial entry, you need to search for and select it from memory.

When you are prompted to enter a fax number while sending a fax, press **Address Book**. See below.



Searching Address Book for an entry

There are two ways to search for a number in memory. You can either scan from A to Z sequentially, or you can search by entering the first letters of the name associated with the number.



Searching sequentially through the memory

1. Press **Fax** () on the control panel.
2. Press **Address Book** () on the control panel.
3. Press the left/right arrow until **Search & Dial** appears and press **OK**.
4. Press the left/right arrow until **Group Dial** appears and press **OK**.
5. Press the left/right arrow until **All** appears and press **OK**.
6. Press the left/right arrow until the name and number you want appears. You can search upwards or downwards through the entire memory in alphabetical order.

Searching sequentially through the memory



1. Press **Fax** () on the control panel.
2. Press **Address Book** () on the control panel.
3. Press the left/right arrow until **Search & Dial** appears and press **OK**.
4. Press the left/right arrow until **Group Dial** appears and press **OK**.
5. Press the left/right arrow until **ID** appears and press **OK**.
6. Enter the first few letters of the name you want.
7. Press the left/right arrow until the group dial's name and number you want appears.

Deleting a Address Book for entry

1. Press **Fax** () on the control panel.
2. Press **Address Book** () on the control panel.
3. Press the left/right arrow until **Delete** appears and press **OK**.
4. Press the left/right arrow until the deleting option you want appears and press **OK**.
5. Press the left/right arrow until the searching method you want appears and press **OK**.
Select **Search All** to search for an entry by scanning through all entries in **Address Book**.
Select **Search ID** to search for an entry by the first few letters of the name.
6. Press the left/right arrow until the name you want appears and press **OK**.
Or, enter the first letters. Press the left/right arrow until the name you want appears and press **OK**.
7. Press **OK** when **Yes** appears to confirm the deletion.
8. Press **Stop/Clear** () to return to ready mode.



Printing Address Book

You can check your **Address Book** settings by printing a list.

1. Press **Fax** () on the control panel.
2. Press **Address Book** () on the control panel.
3. Press the left/right arrow until **Print** appears and press **OK**.
The machine begins printing.

Printing sent fax report automatically

You can set the machine to print a report with detailed information about the previous 50 communication operations, including time and dates.

1. Press **Fax** () on the control panel.
2. Press **Menu** () on the control panel.
3. Press the left/right arrow until **Fax Setup** appears and press **OK**.
4. Press the left/right arrow until **Auto Report** appears and press **OK**.
5. Press the left/right arrow until **On** appears and press **OK**.
6. Press **Stop/Clear** () to return to ready mode.

Machine status and advanced feature

This chapter explains how to browse the current status of your machine, and the method of setting for the advanced machine setup. Read this chapter carefully in order to use your machine's diverse features.

This chapter includes:

- [Fax setup](#)
- [Copy setup](#)
- [Printing a report](#)
- [Clearing memory](#)
- [Network](#)
- [Menu overview](#)

Fax setup

Changing the fax setup options

Your machine provides you with various user-selectable options for setting up the fax system. You can change the default settings for your preferences and needs.

To change the fax setup options:

1. Press **Fax** (📠) on the control panel.
2. Press **Menu** (☰) on the control panel.
3. Press the left/right arrow until **Fax Setup** appears and press **OK**.
4. Press the left/right arrow until the fax setup item you want appears and press **OK**.
5. Press the left/right arrow until the option you want appears and press **OK**.
6. Press the left/right arrow until the desired status appears or enter the value for the option you have selected, and press **OK**.
7. If necessary, repeat steps 4 through 6.
8. Press **Stop/Clear** (⏹) to return to ready mode.

Sending

Option	Description
Redial Times	You can specify the number of redial attempts. If you enter 0, the machine will not redial.
Redial Term	Your machine can automatically redial a remote fax machine if it was busy. You can set an interval between attempts.
Prefix Dial	You can set a prefix of up to five digits. This number dials before any automatic dial number is started. It is useful for accessing a PABX exchange.
ECM Mode	This mode helps with poor line quality and makes sure any faxes you send are sent smoothly to any other ECM-equipped fax machine. Sending a fax using ECM may take more time.
Send Report	You can set your machine to print a confirmation report showing whether a transmission was successful, how many pages were sent, and more. The available options are On , Off , and On-Error , which prints only when a transmission is not successful.
Image TCR	This function allows users to know what fax messages have been sent by showing sent messages in the transmission report. The first page of the message is turned into an image file than is printed on the transmission report so the users can see what messages have been sent. However, you can not use this function when sending fax without saving the data in the memory.
Dial	This setting may not be available depending on your country. If you cannot reach this option, your

Mode	<p>machine does not support this feature.</p> <p>You can set the dial mode for your machine to either tone dialling or pulse dialling. If you have a public telephone system or a private branch exchange (PBX) system, you may need to select Pulse. Contact your local telephone company if you are not sure which dial mode to use.</p> <p>If you select Pulse, some phone system features might not be available. It can also take longer to dial a fax or phone number.</p>
-------------	--

Receiving

Option	Description
Receive Mode	You can select the default fax receiving mode. For details on receiving faxes in each mode, see Changing the receive modes .
Ring To Answer	You can specify the number of times the machine rings before answering an incoming call.
Stamp RCV Name	This option allows the machine to automatically print the page number, and the date and time of reception at the bottom of each page of a received fax.
RCV Start Code	This code allows you to initiate fax reception from an extension phone plugged into the EXT socket on the back of the machine. If you pick up the extension phone and hear fax tones, enter the code. It is preset to *9* at the factory.
Auto Reduction	<p>When receiving a fax containing pages as long as or longer than the paper loaded in the paper tray, the machine can reduce the size of the original to fit the size of the paper loaded in the machine. Turn on this feature if you want to automatically reduce an incoming page.</p> <p>With this feature set to Off, the machine cannot reduce the original to fit onto one page. The original will be divided and printed in actual size on two or more pages.</p>
Discard Size	<p>When receiving a fax containing pages as long as or longer than the paper in your machine, you can set the machine to discard a specific length from the end of the received fax. The machine will print the received fax on one or more sheets of paper, minus the data that would have been on the specified discard segment.</p> <p>When the received fax contains pages larger than the paper in your machine, and Auto Reduction has been turned on, the machine will reduce the fax to fit on the existing paper, and nothing will be discarded.</p>
Junk Fax Setup	<p>This setting may not be available depending on your country. Using this feature, the system will not accept faxes sent from remote stations whose numbers are stored in the memory as junk fax numbers. This feature is useful for blocking any unwanted faxes.</p> <p>When you turn on this feature, you can access the following options to set junk fax numbers.</p> <ul style="list-style-type: none"> • Add: Allows you to set up to 10 fax numbers. • Delete: Allows you to delete the desired junk fax number. If you select Delete All, Allows you to delete all junk fax numbers.
DRPD Mode	This mode enables a user to use a single telephone line to answer several different telephone numbers. In this menu, you can set the machine to recognize which ring patterns to answer. For details about this feature, see Receiving faxes using DRPD mode .

Change Default

Option	Description
Resolution	<p>Changing the resolution setting affects the appearance of the received document.</p> <ul style="list-style-type: none"> • Standard: Originals with normal sized characters. • Fine: Originals containing small characters or thin lines or originals printed using a dot-matrix printer. • Super Fine: Originals containing extremely fine detail. Super Fine mode is enabled only if the machine with which you are communicating also supports the Super Fine resolution. <ul style="list-style-type: none"> ◦ For memory transmission, Super Fine mode is not available. The resolution setting is automatically changed to Fine. ◦ When your machine is set to Super Fine resolution and the fax machine with which you are communicating does not support Super Fine resolution, the machine transmits using the highest resolution mode supported by the other fax machine. • Photo Fax: Originals containing shades of gray or photographs. • Color Fax: Originals with colors. Sending a color fax is enabled only if the machine with which you are communicating supports color fax reception and you send the fax manually. In this mode,

	memory transmission is not available.
Darkness	You can select the default contrast mode to fax your originals lighter or darker.

Auto Report

You can set the machine to print a report with detailed information about the previous 50 communication operations, including time and dates.

For further details, see [Printing sent fax report automatically](#).

Copy setup

Changing the copy setup options

For copy output, you can set up several options in advance.

1. Press **Copy** (📄) on the control panel.
2. Press **Menu** (☰) on the control panel.
3. Press the left/right arrow until **Copy Setup** appears and press **OK**.
4. Press the left/right arrow until the copy setup item you want appears and press **OK**.
5. Press the left/right arrow until the setup option you want appears and press **OK**.
6. Press the left/right arrow until the setting you want appears and press **OK**.
7. Repeat steps 4 through 6, as needed.
8. Press **Stop/Clear** (⏹) to return to ready mode.

Change Default

Option	Description
Copies	You can enter the number of copies using the number keypad.
Copy Collation	You can set the machine to sort the copy job. For further details, see Deciding the form of copy output .
Reduce/Enlarge	Reduces or enlarges the size of a copied image.
Darkness	Adjusts the brightness level to make a copy that is easier to read, when the original contains faint markings and dark images.
Original Type	Improves the copy quality by selecting the document type for the current copy job.

Printing a report

You can print a report on the machine's configuration or font list, etc.

1. Press **Menu** (☰) on the control panel.
2. Press the left/right arrow until **System Setup** appears and press **OK**.
3. Press the left/right arrow until **Report** appears and press **OK**.
4. Press the left/right arrow until the report or list you want to print appears and press **OK**.
To print all reports and lists, select **All Report**.
5. Press **OK** when **Yes** appears to confirm printing.
The selected information prints out.



Option	Description
Configuration	This list shows the status of the user-selectable options. You may print this list to confirm your changes after changing settings.
Phone Book	This list shows all of the fax numbers currently stored in the machine's memory.
Send Report	This report shows the fax number, the number of pages, the elapsed time of the job, the communication mode, and the communication results for a particular fax job. You can set up your machine to automatically print a transmission confirmation report after each fax job (See Sending).
Sent Report	This report shows information on the faxes you have recently sent. You can set the machine to automatically print this report every 50 communications (See Sending).
Fax RCV Report	This report shows information on the faxes you have recently received.
Schedule	This list shows the documents currently stored for delayed faxes along with the starting time and

Jobs	type of each operation.
JunkFax Report	This list shows the fax numbers specified as junk fax numbers. To add or delete numbers to or from this list, access the Junk Fax Setup menu (See Receiving).
Network Info.	This list shows information on your machine's network connection and configuration.

-  You can also print the machine's status information and browse status with Embedded Web Service. Open the Web browser on your networked computer and type the IP address of your machine. When Embedded Web Service opens, click **Information** > **Print information**.

Clearing memory

You can selectively clear information stored in your machine's memory.



1. Press **Menu** () on the control panel.
2. Press the left/right arrow until **System Setup** appears and press **OK**.
3. Press the left/right arrow until **Clear Setting** appears and press **OK**.
4. Press the left/right arrow until the item you want to clear appears and press **OK**.
5. Press **OK** when **Yes** appears to confirm clearing.
6. Repeat steps 4 through 5 to clear another item.
7. Press **Stop/Clear** () to return to ready mode.

-  Some menus may not appear in the display depending on options or models. If so, it is not applicable to your machine.

Option	Description
All settings	Clears all of the data stored in memory and resets all of your settings to the factory default.
Fax Setup	Restores all of the fax options to the factory default.
Copy Setup	Restores all of the copy options to the factory default.
Scan Setup	Restores all of the scan options to the factory default.
System Setup	Restores all of the system options to the factory default.
Network Setup	Restores all of the network options to the factory default.
Phone Book	Clears all of the fax numbers entries stored in memory.
Sent Report	Clears all records of sent faxes.
RCV Report	Clears all records of received faxes.

Network

You may set up the network with the machine's display screen. Before doing that, you must have the relevant information concerning the type of network protocols and computer system you use. If you are not sure which setting to use, contact your network administrator to configure this machine to the network.

1. Press **Menu** () on the control panel.
2. Press the left/right arrow until **Network** appears and press **OK**.
3. Press the left/right arrow until the setup option you want appears and press **OK**.
4. Press the left/right arrow until the setting you want appears and press **OK**.
5. Repeat steps 3 through 4, as needed.
6. Press **Stop/Clear** () to return to ready mode.

Option	Description
TCP/IP (IPv4)	Select appropriate protocol and configure parameters to use the network environment.  There are lots of parameters to be set; therefore, if you are not sure, leave as is, or consult the network administrator.
TCP/IP (IPv6)	Selects this option to use the network environment through IPv6 (See IPv6 Configuration).
Ethernet Speed	Configure the network transmission speed.
Clear	Reverts the network settings to the default values.

Setting	
Network Info	This list shows information on your machine's network connection and configuration.

Menu overview

The control panel provides access to various menus to set up the machine or use the machine's functions. These menus can be accessed by pressing **Menu** (☰).

 Some menus may not appear in the display depending on options or models. If so, it is not applicable to your machine.

Items	Option
Fax Feature	Darkness Resolution Multi Send Delay Send Priority Send Forward Secure Receive Add Page Cancel Job
Fax Setup	Sending Redial Times Redial Term Prefix Dial ECM Mode Send Report Image TCR Dial Mode Receiving Receive Mode Ring To Answer Stamp RCV Name RCV Start Code Auto Reduction Discard Size Junk Fax Setup DRPD Mode Change Default Resolution Darkness Auto Report
Copy Feature	Reduce/Enlarge Darkness Original Type Layout Adjust Bkgd.
Copy Setup	Scan Size Change Default Copies Copy Collation Reduce/Enlarge Darkness Original Type
System Setup	Machine Setup Machine ID Machine Fax No

	<p> Date & Time Clock Mode Language Default Mode Power Save Timeout Job Timeout Altitude Adj. Toner Save </p> <p> Paper Setup Paper Size Paper Type Paper Source </p> <p> Sound/Volume Key Sound Alarm Sound Speaker Ringer </p> <p> Report All Report Configuration Phone Book Send Report Sent Report Fax RCV Report Schedule Jobs JunkFax Report Network Info. </p> <p> Maintenance CLR Empty Msg Supplies Life TonerLow Alert Serial Number Paper Stacking </p> <p> Clear Setting All Settings Fax Setup Copy Setup Scan Setup System Setup Network Setup Phone Book Sent Report RCV Report </p>
Network	<p> TCP/IP (IPv4) DHCP BOOTP Static </p> <p> TCP/IP (IPv6) IPv6 Activate DHCPv6 Config </p> <p> Ethernet Speed Clear Setting Network Info. </p>

Maintenance

This chapter provides information for maintaining your machine and the toner cartridge.

This chapter includes:

- [Printing a machine report](#)
- [Monitoring the supplies life](#)
- [Using toner low alert](#)
- [Finding the serial number](#)
- [Cleaning the machine](#)
- [Storing the Toner cartridge](#)
- [Tips for moving & storing your machine](#)

Printing a machine report



You can print the machine's information and job report.

1. Press **Menu** () on the control panel.
2. Press the left/right arrow until **System Setup** appears and press **OK**.
3. Press the left/right arrow until **Report** appears and press **OK**.
4. Press the left/right arrow until the report or list you want to print appears and press **OK**.
To print and lists, select **All Reports**.
5. Press the left/right arrow until **Yes** appears at the **Print?** prompt and press **OK**.

 You can use SyncThru™ Web Service to print the machine's configuration or browse the status. Open the web browser in the networked computer and type the machine's IP address. When Embedded Web Service opens, click **Information > Print information**.

Monitoring the supplies life

If you experience frequent paper jams or printing problems, check the number of pages the machine has printed. Replace the corresponding parts, if necessary.

1. Press **Menu** () on the control panel.
2. Press the left/right arrow until **System Setup** appears and press **OK**.
3. Press the left/right arrow until **Maintenance** appears and press **OK**.
4. Press the left/right arrow until **Supplies Life** appears and press **OK**.
5. Press the left/right arrow until the item you want appears and press **OK**.
 - **Supplies Info**: Prints the supply information page.
 - **Total**: Displays the total number of pages printed.
 - **ADF Scan**: Displays the number of pages scanned using the ADF.
 - **Platen Scan**: Displays the number of pages scanned using the scanner glass.
6. Press **Stop/Clear** () to return to ready mode.

Using toner low alert

If the amount of toner in the cartridge is low, a message informing user to change the toner cartridge appears. You can set the option for this message to appear or not.

In the control panel

1. Press **Menu** () on the control panel.
2. Press the left/right arrow until **System Setup** appears and press **OK**.
3. Press the left/right arrow until **Maintenance** appears and press **OK**.
4. Press the left/right arrow until **TonerLow Alert** appears and press **OK**.

5. Select the appropriate setting and then click **OK**.
6. Press **Stop/Clear** (⏹) to return to ready mode.

In the computer

1. Ensure that you have installed the printer driver with the provided software CD.
2. You can launch Printer Settings Utility from the **Start** menu, select **Programs** or **All Programs** > **Dell** > **Dell Printers** > **your printer driver name** > **Printer Settings Utility**.
3. Click **Printer Setting**.
4. Click **Setting** > **Toner Low Alert**. Select the appropriate setting and then click **Apply**.

Finding the serial number

When you call for service or register as a user on the Dell website, the machine's serial number by taking the following steps:

1. Press **Menu** (☰) on the control panel.
2. Press the left/right arrow until **System Setup** appears and press **OK**.
3. Press the left/right arrow until **Maintenance** appears and press **OK**.
4. Press the left/right arrow until **Serial Number** appears and press **OK**.
5. Check your machine's serial number.
6. Press **Stop/Clear** (⏹) to return to ready mode.

Cleaning the machine

If printing quality problems occur or if you use your machine in a dusty environment, you need to clean your machine regularly to keep the best printing condition and use your machine longer.

- ⚠ • Cleaning the cabinet of the machine with cleaning materials containing large amounts of alcohol, solvent, or other strong substances can discolor or distort the cabinet.
- If your machine or the surrounding area is contaminated with toner, use a cloth or tissue dampened with water to clean it. If you use a vacuum cleaner, toner blows in the air and might be harmful.

Cleaning the outside

Clean the machine cabinet with a soft, lint-free cloth. Dampen the cloth slightly with water, but be careful not to let any water drip onto or into the machine.

Cleaning the inside

During the printing process, paper, toner, and dust particles can accumulate inside the machine. This buildup can cause print quality problems, such as toner specks or smearing. Cleaning the inside of the machine clears and reduces these problems.

1. Turn the machine off and unplug the power cord. Wait for the machine to cool down.
2. Open the front door and pull the toner cartridge out. Set it on a clean flat surface

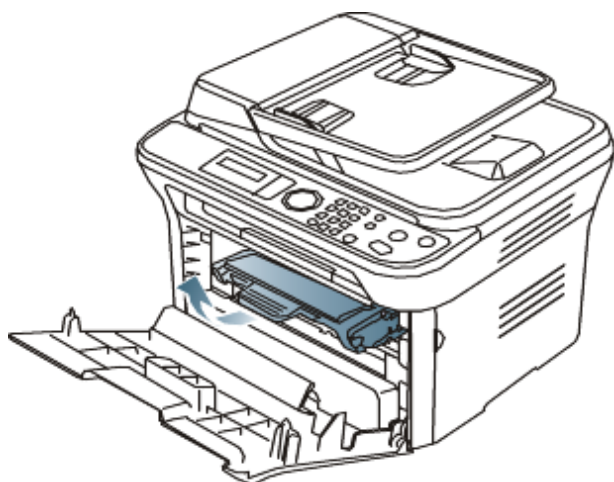

- ⚠ • To prevent damage to the toner cartridge, do not expose it to light for more than a few minutes. Cover it with a piece of paper, if necessary.
 - Do not touch the green surface underside of the toner cartridge. Use the handle on the cartridge to avoid touching this area.
3. With a dry, lint-free cloth, wipe away any dust and spilt toner from the toner cartridge area.

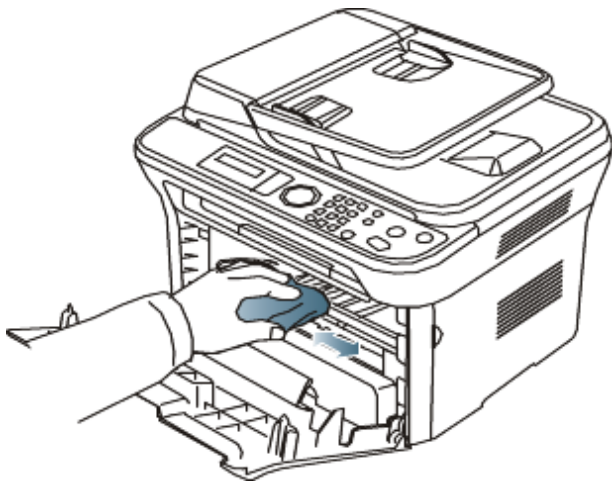

⚠ While cleaning the inside of the machine, be careful not to damage the transfer roller or any other inside parts. Do not use solvents such as benzene or thinner to clean. Printing quality problems can occur and cause damage to the machine.

4. Locate the long strip of glass (LSU) inside the top of the cartridge compartment and gently clean the glass with a swab.

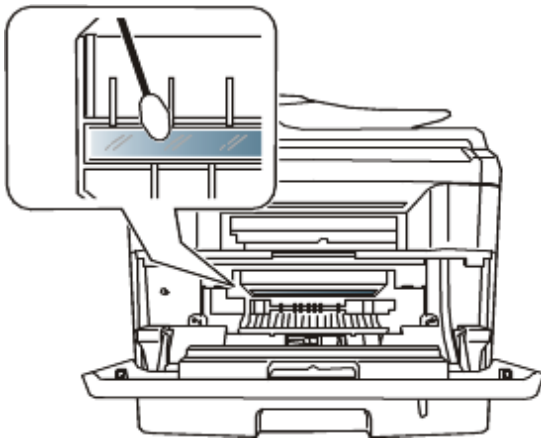

5. Reinsert the toner cartridge and close the front door.
6. Plug in the power cord and turn the machine on.

Cleaning the scan unit

Keeping the scan unit clean helps ensure the best possible copies. We suggest that you clean the scan unit at the start of each day and during the day, as needed.

1. Slightly dampen a soft, lint-free cloth or paper towel with water.
2. Open the scanner lid.
3. Wipe the surface of the scanner glass and the document feeder glass until it is clean and dry.

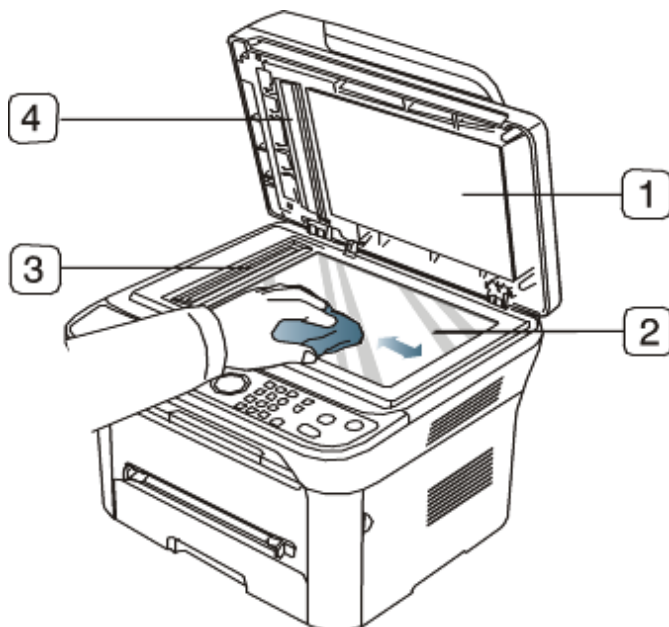

1. Scanner lid
2. Scanner glass
3. Document feeder glass
4. White bar

4. Wipe the underside of the scanner lid and white bar until it is clean and dry.
5. Close the scanner lid.

Storing the Toner cartridge

Toner cartridges are sensitive to light, temperature, and humidity. It is recommended that users follow these recommendations to ensure optimum performance, highest quality, and longest life from your new Dell toner cartridge. Store this cartridge in the same environment as the printer it will be used in; this should be in controlled office temperature and humidity conditions. The toner cartridge should remain in its original, unopened package until installation – If original packaging is not available, cover the top opening of the cartridge with paper and store in a dark cabinet.

Opening the cartridge package prior to use significantly shortens its useful shelf and operating life. Do not store on the floor. If the toner cartridge is removed from the printer, always store the cartridge:

- Inside the protective bag from the original package.
- Store lying flat (not standing on end) with the same side facing up as if they were installed in the machine.
- Do not store the toner in
 - Temperature greater than 40 °C (104 °F).
 - Humidity range less than 20% and not greater than 80%.
 - An environment with extreme changes in humidity or temperature.
 - Direct sunlight or room light.
 - Dusty places.
 - A car for a long period of time.
 - An environment where corrosive gases are present.
 - An environment with salty air.

Handling instructions

- Do not touch the surface of the photosensitive drum in the cartridge.
- Do not expose the cartridge to unnecessary vibrations or shock.
- Never manually rotate the drum, especially in the reverse direction; this can cause internal damage and toner spillage.

Use of non-Dell and refilled toner cartridge

Dell does not recommend or approve the use of non-Dell brand toner cartridges in your printer including generic, store brand, refilled, or remanufactured toner cartridges.

 Dell's printer warranty does not cover damage to the machine caused by the use of a refilled, remanufactured, or non-Dell brand toner cartridge.

Estimated cartridge life

Estimated cartridge life (the life of the toner cartridge yield) depends on the amount of toner that print jobs require. The actual print-out number may vary depending on the print density of the pages you print on, operating environment, printing interval, media type, and/or media size. For example, if you print a lot of graphics, the consumption of the toner is high and you may need to change the cartridge more often.

Tips for moving & storing your machine

- When moving the machine, do not tilt or turn it upside down. Otherwise, the insides of the machine may be contaminated by toner, which can cause damage to the machine or bad print quality.
- You require at least two people to move the machine.

Management tools

This chapter introduces the different management tools provided.

This chapter includes:

- [Introducing useful management tools](#)
- [Using Embedded Web Service](#)
- [Using the Printer Status Monitor](#)
- [Smarthru](#)
- [Using the Linux Unified Driver Configurator](#)

Introducing useful management tools

The programs below help you to use your machine conveniently.

- [Using Embedded Web Service](#).
- [Using the Printer Status Monitor](#).
- [Smarthru](#).
- [Using the Linux Unified Driver Configurator](#).

Using Embedded Web Service

 Your Embedded Web Service window that appears in this user's guide may differ depending on the machine in use. If you have connected your machine to a network and set up TCP/IP network parameters correctly, you can manage the machine via Embedded Web Service, an Embedded web server. Use Embedded Web Service to:

- View the machine's device information and check its current status.
- Change TCP/IP parameters and set up other network parameters.
- Change printer preference.
- Set the email notifications advising of the machine's status.
- Get support for using the machine.

To access Embedded Web Service:

1. Access a web browser, such as Internet Explorer, from Windows.
Enter the machine IP address (<http://xxx.xxx.xxx.xxx>) in the address field and press the Enter key or click **Go**.
2. Your machine's Embedded website opens.

Embedded Web Service overview

- **Information tab:** This tab gives you general information about your machine. You can check things, such as the machine's IP address, remaining amount of toner, ethernet information, firmware version, and so on. You can also print reports such as an error report and so on.
- **Machine Settings tab:** This tab allows you to set options provided by your machine.
- **Network Settings tab:** This tab allows you to view and change the network environment. You can set things, such as TCP/IP, enabling Ether Talk and so on.
- **Maintenance tab:** This tab allows you to maintain your machine by upgrading firmware and setting security information.
- **Support tab:** This tab allows you to set contact information for sending email. You can also connect to SEC website or download drivers by selecting Link.

Setting the contact information

Set the machine administrator information and this setting is necessary to use E-mail notification option.

1. Start a web browser, such as Internet Explorer, from Windows.
Enter the machine IP address (<http://xxx.xxx.xxx.xxx>) in the address field and press the Enter key or click Go.
2. Your machine's Embedded website opens.
Select **Support**.

- 3.
4. Enter the name of machine administrator, phone number, location or E-mail address.
5. Click **Apply**.

 If the firewall is activated, the E-mail may not be sent successfully. In that case, contact the a network administrator.

Using the Printer Status Monitor

The Printer Status Monitor program can only be used on computers running Microsoft Windows operating system. The Printer Status Monitor program can only be used on computers running Microsoft Window operating system.

Printer Status Monitor is installed automatically when you install the machine software.

-  To use this program, you need the following system requirements:
- Windows. Check for windows operating system(s) compatible with your machine. (See [System requirements.](#))

Understanding Printer Status Monitor

If an error occurs while printing, you can check the error from the Printer Status Monitor.

You can launch Printer Status Monitor from the **Start** menu, select **Programs** or **All Programs** > **Dell** > **Dell Printers** > **your printer driver name** > **Printer Status Monitor**.

The Printer Status Monitor program displays the current status of the machine, the estimated level of toner remaining in the toner cartridge(s), and various other types of information.

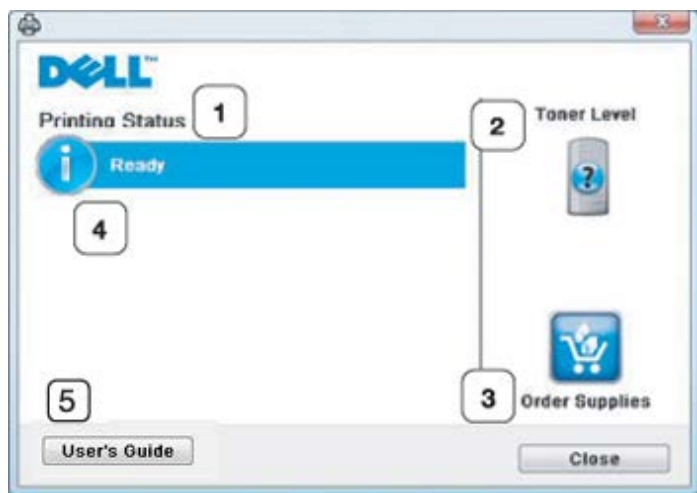

1	Printing Status	The Printer Status Monitor displays the current status of the printer.
2	Toner Level	View the level of toner remaining in the toner cartridge(s).
3	Order Supplies	Order replacement toner cartridge(s) online.
4	Help me	When error occurs, Help me button appears. You can directly open troubleshooting section in the user's guide.
5	User's Guide	View User's Guide.

Changing the Printer Status Monitor Program Settings

Right-click the Printer Status Monitor icon and select **Options**. Select the settings you want from the **Options** window.

Using the Dell 1135n Laser MFP Toner Reorder

The Dell 1135n Laser MFP Toner Reorder window also displays the level of toner remaining and allows you to order replacement toner cartridge.

Using the Printer Settings Utility

When you install the Dell software, the Printer Settings Utility is automatically installed.

To open the Printer Settings Utility.

If you are a Windows user, you can launch Printer Settings Utility from the **Start** menu, select **Programs** or **All Programs** > **Dell** > **Dell Printers** > **your printer driver name** > **Printer Settings Utility**.

The Printer Settings Utility window provides several features.

For more information, click the help icon button.

Firmware update utility

Firmware Update Utility allows you to maintain your machine by upgrading firmware.

If you are a Windows user, you can launch Firmware Update Utility from the **Start** menu, select **Programs** or **All Programs** > **Dell** > **Dell Printers** > **your printer driver name** > **Firmware Update Utility**.

Smarthru

The supplied software CD provides you with SmarThru. SmarThru offers you convenient features to use with your machine.

Starting SmarThru

Follow the steps below to start SmarThru:

1. Make sure that your machine and computer are turned on and properly connected to each other.
2. Once you have installed SmarThru, you will see the SmarThru icon on your desktop.
3. Double-click the SmarThru icon.



4. The SmarThru appears.

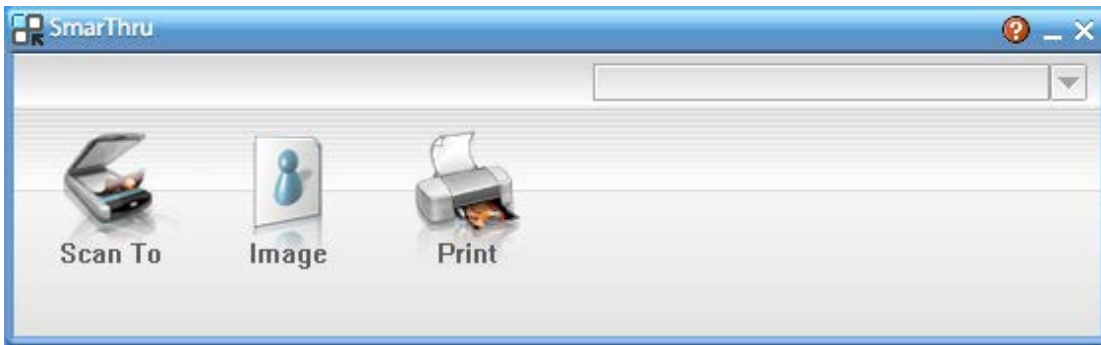

- **Scan To:** Allows you to scan an image and save it to an application or folder, email it, or publish it on a web site.
- **Image:** Allows you to edit an image you have saved as a graphic file and send it to a selected application or folder, email it, or publish it on a web site.
- **Print:** Allows you to print images you have saved. You can print images in black and white or color mode if your machine supports it.

For more information about SmarThru, click  at the top right corner of the window. The SmarThru help window appears; you can view on screen help supplied on the SmarThru program.

 Follow the steps below to uninstall SmarThru. Before you begin the uninstall, ensure that all applications are closed on your computer.

1. From the **Start** menu, select **Programs** or **All Programs**.
2. Select **Dell Printers** > **SmarThru 4** > **Uninstall SmarThru 4**.
3. When your computer asks you to confirm your selection, read the statement and click **OK**.
4. Click **Finish**.

Using SmarThru

Scanning

1. Click **Scan To**.

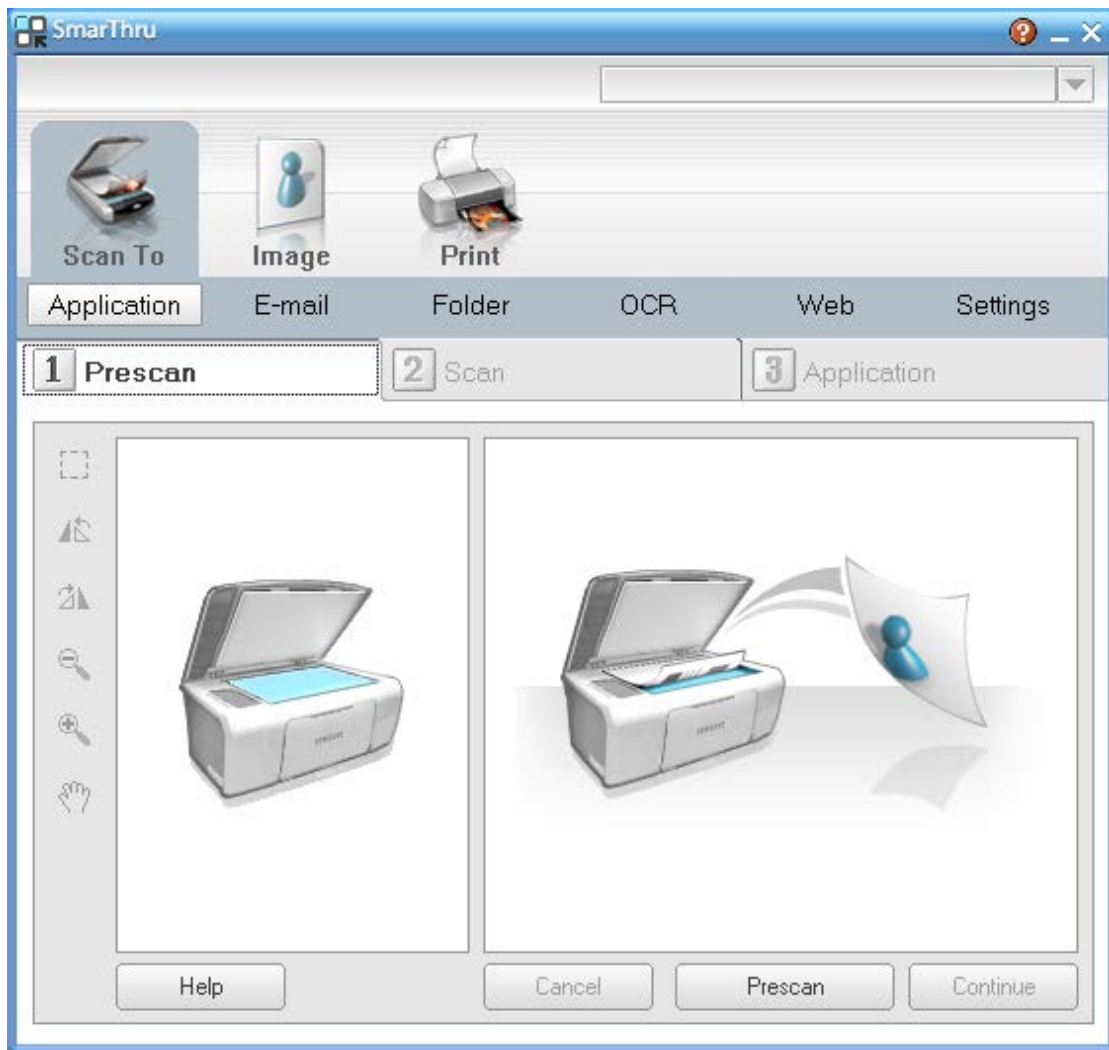

- **Application:** Scanning an image and placing it in an image editor application, such as Paint or Adobe Photoshop.
 - **E-mail:** Scanning an image and emailing it. Allows you to scan an image, preview it, and email it.
 - ✍ To send an image by e-mail, you must have a mail client program, like Outlook Express, which has been set up with your e-mail account.
 - **Folder:** Scanning an image and saving it to a folder. Allows you to scan an image, preview it, and save it to the folder of your choice.
 - **OCR:** Scanning an image and performing text recognition. Allows you to scan an image, preview it, and send it to the OCR program for text recognition.
 - Recommended scan option for OCR.
 - Resolution: 200 or 300 dpi.
 - Image type: grayscale or black & white.
 - **Web:** Scanning an image, previewing it, and publishing it on a web site, using the specified file format for the image you want to publish.
 - **Settings:** Customizing settings of **Scan To** basic functions. Allows you to customize settings for **Application**, **E-mail**, **OCR**, and **Web** functions.
2. Set scan settings and click **Scan**.

Printing

1. Click **Print**.
2. Select the file you want to print.
3. Select the machine you want to use for printing.
4. Click **Print** to start the job.

Using the Linux Unified Driver Configurator

Unified Driver Configurator is a tool primarily intended for configuring machine devices.

Opening the Unified Driver Configurator

1. Double-click the **Unified Driver Configurator** on the desktop.
You can also click the **Startup** Menu icon and select **Dell Unified Driver > Unified Driver Configurator**.
2. Click each button on the left to switch to the corresponding configuration window.

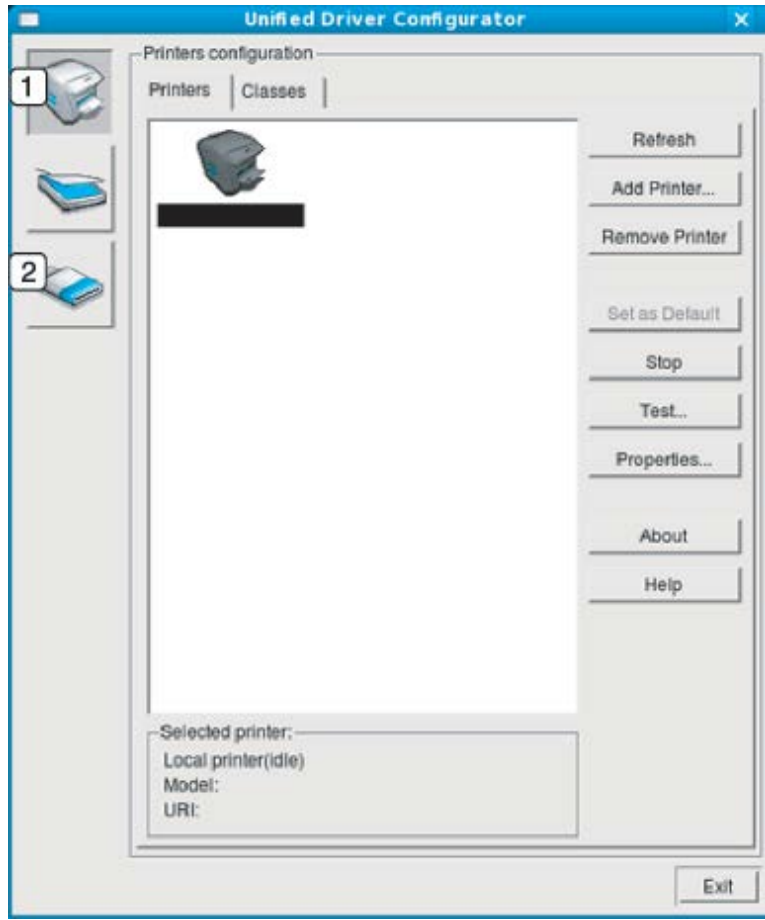

1. Printers Configuration
2. Scanners Configuration
3. Ports Configuration

 To use the on screen help, click **Help**.

3. After changing the configurations, click **Exit** to close the Unified Driver Configurator.

Printers configuration

Printers configuration has the two tabs: **Printers** and **Classes**.

Printers tab

View the current system's printer configuration by clicking on the machine icon button on the left side of the Unified Driver Configurator window.

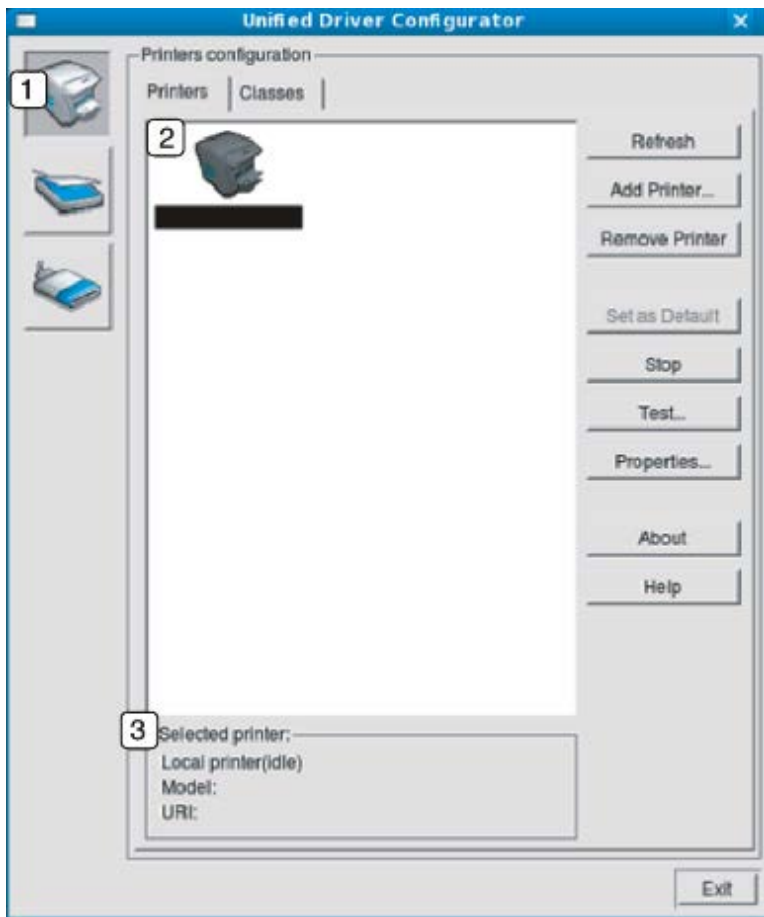

1	Switches to Printers configuration .
2	Shows all of the installed machine.
3	Shows the status, model name and URI of your machine.

The printer control buttons are, as follows:

- **Refresh:** Renews the available machines list.
- **Add Printer:** Allows you to add a new machines.
- **Remove Printer:** Removes the selected machine.
- **Set as Default:** Sets the current selected machine as a default machine.
- **Stop/Start:** Stops/starts the machine.
- **Test:** Allows you to print a test page to ensure the machine is working properly.
- **Properties:** Allows you to view and change the printer properties.

Classes tab

The Classes tab shows a list of available machine classes.

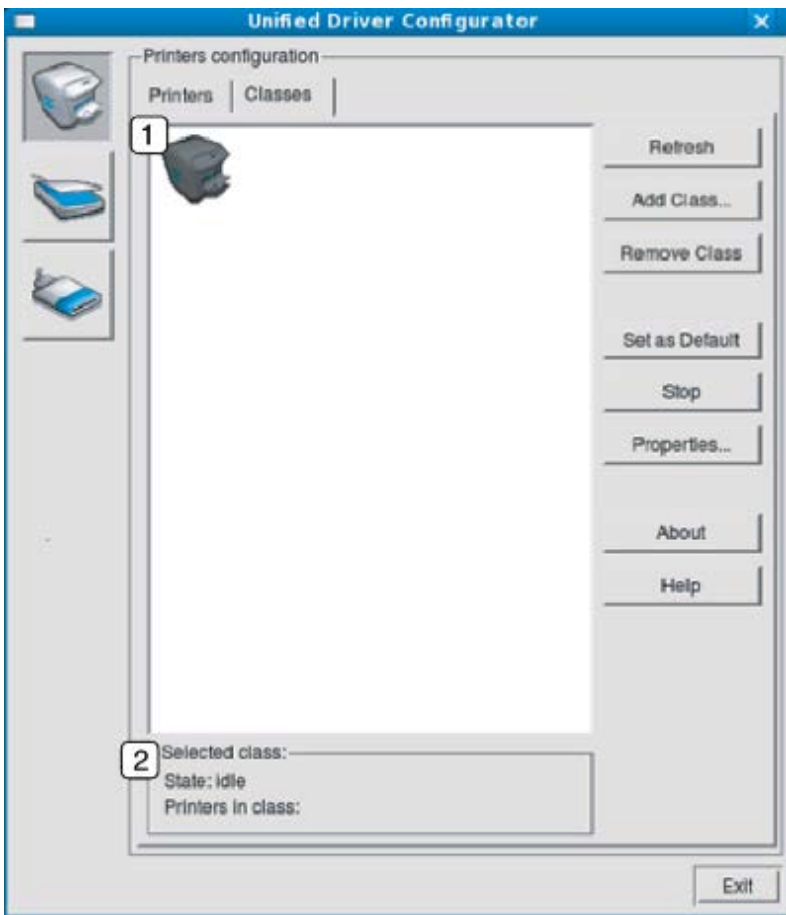

1	Shows all of the machine classes.
2	Shows the status of the class and the number of machines in the class.

- **Refresh:** Renews the classes list.
- **Add Class:** Allows you to add a new machine class.
- **Remove Class:** Removes the selected machine class.

Scanners configuration

In this window, you can monitor the activity of scanner devices, view a list of installed Dell machine devices, change device properties, and scan images.

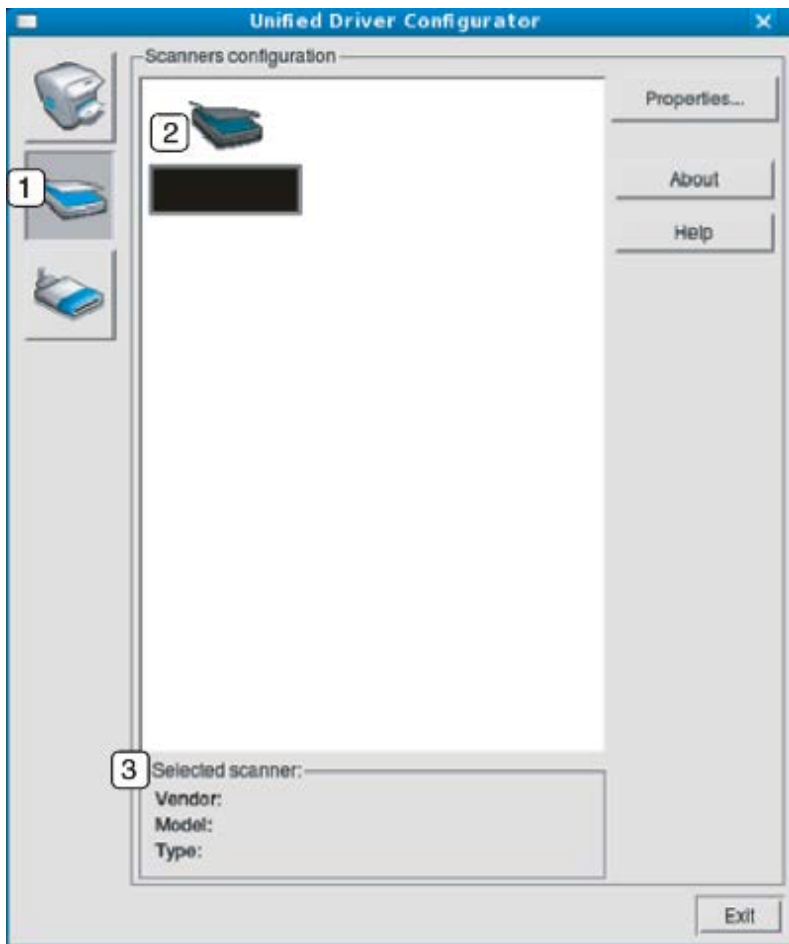

1	Switches to Scanners configuration .
2	Shows all of the installed scanners.
3	Shows the vendor, model name and type of your scanner.

- **Properties:** Allows you to change the scan properties and scan a document.

Ports configuration

In this window, you can view the list of available ports, check the status of each port and release a port that is stalled in a busy state when its users has terminated the job for any reason.

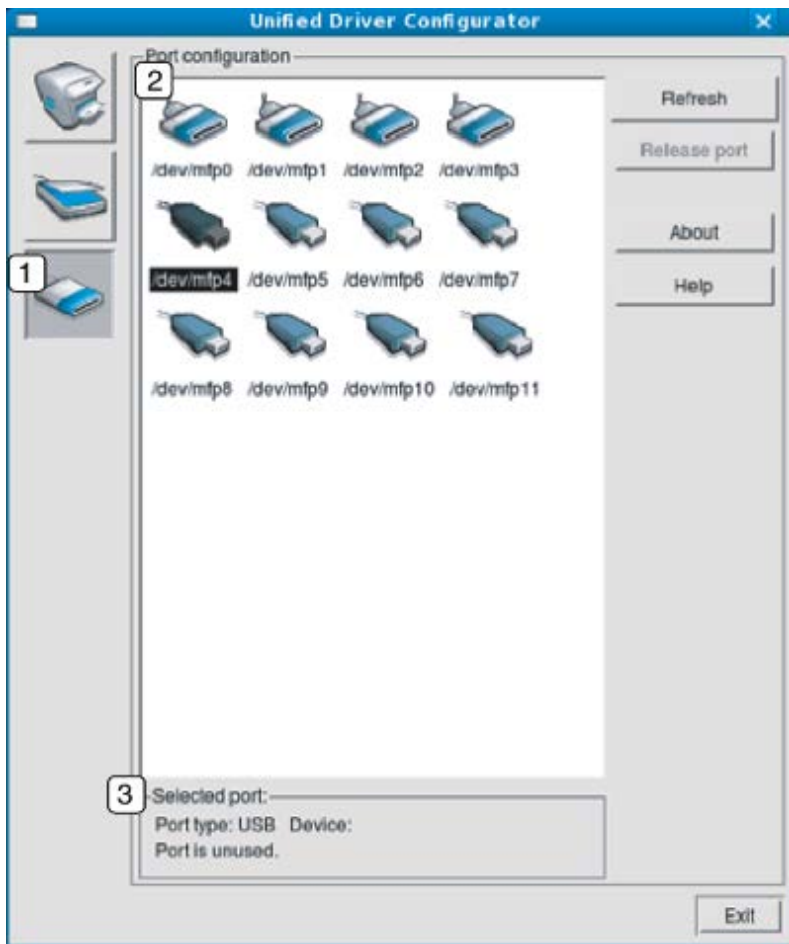

1	Switches to Ports configuration .
2	Shows all of the available ports.
3	Shows the port type, device connected to the port, and status.

- **Refresh**: Renews the available ports list.
- **Release port**: Releases the selected port.

Sharing Ports Between Printers and Scanners

Your machine may be connected to a host computer via a parallel port or USB port. Since the printer contains more than one device (printer and scanner), it is necessary to organize proper access of user-installed applications to these devices via the single I/O port.

The Unified Linux Driver package provides an appropriate port sharing mechanism that is used by Dell printer and scanner drivers. The drivers talk to their devices via so-called machine ports. The current status of any machine port can be viewed via the **Ports configuration**. The port sharing prevents you from accessing one functional block of the machine device, while another block is in use.

When you install a new machine device onto your system, it is strongly recommended you do this with the assistance of an Unified Driver Configurator. In this case you will be asked to choose I/O port for the new device. This choice will provide the most suitable configuration for machine's functionality. For machine scanners, I/O ports are being chosen by scanner drivers automatically, so proper settings are applied by default.

Media and tray

This chapter provides information on how to load originals and print media into your machine.

This chapter includes:

- [Preparing originals](#)
- [Loading originals](#)
- [Selecting print media](#)
- [Changing the tray size](#)
- [Loading paper in the tray](#)
- [Printing on special media](#)
- [Setting the paper size and type](#)
- [Using the output support](#)

 Supported optional devices and features may differ according to your model. Please check your model name. (See [Features by Model](#)).

Preparing originals

- Do not load paper smaller than 142 x 148 mm (5.6 x 5.8 inches) or larger than 216 x 356 mm (8.5 x 14 inches).
- Do not attempt to load the following types of paper, in order to prevent paper jam, low print quality, and machine damage.
 - Carbon-paper or carbon-backed paper
 - Coated paper
 - Onion skin or thin paper
 - Wrinkled or creased paper
 - Curled or rolled paper
 - Torn paper
- Remove all staples and paper clips before loading.
- Make sure any glue, ink, or correction fluid on the paper is completely dry before loading.
- Do not load originals that include different sizes or weights of paper.
- Do not load booklets, pamphlets, transparencies, or documents with other unusual characteristics.

Loading originals

You can use the scanner glass or the automatic document feeder to load an original for copying, scanning, and sending a fax.

On the scanner glass

Make sure that no originals are in the document feeder. If an original is detected in the document feeder, the machine gives it priority over the original on the scanner glass. To get the best scan quality, especially for colored or gray-scaled images, use the scanner glass.

1. Lift and open the scanner lid.

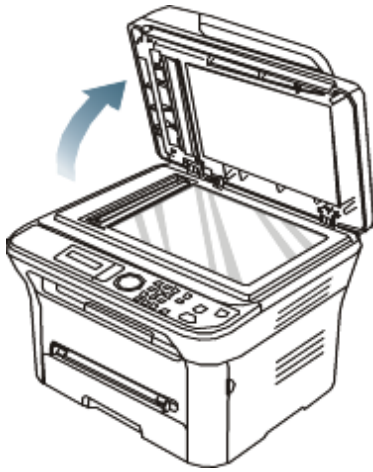

2. Place the original face down on the scanner glass. And align it with the registration guide at the top left corner of the glass.

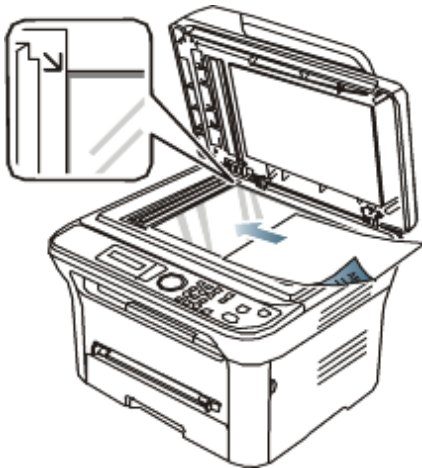

3. Close the scanner lid.



- Leaving the scanner lid open while copying may affect copy quality and toner consumption.
- Dust on the scanner glass may cause black spots on the printout. Always keep it clean (See [Cleaning the scan unit](#)).
- If you are copying a page from a book or magazine, lift the scanner lid until its hinges are caught by the stopper and then close the lid. If the book or magazine is thicker than 30 mm, start copying with the lid open.



- Be careful not to damage the scanner glass. You may get hurt.
- Do not put your hands on the scanner unit while closing the scanner lid. The scanner lid may fall on your hands and cause injury.
- Do not look the light from inside of the scanner while copying or scanning. It is harmful to eyes.

In the document feeder

Using the document feeder, you can load up to 40 sheets of paper (75 g/m², 20 lb bond) for one job.

1. Flex or fan the edge of the paper stack to separate the pages before loading originals.



2. Load the original face up into the document feeder. Make sure that the bottom of the original stack matches the paper size marked on the document input tray.

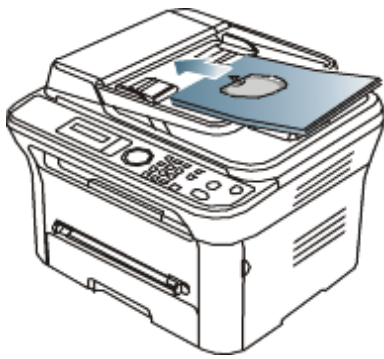

3. Adjust the document feeder width guides to the paper size.

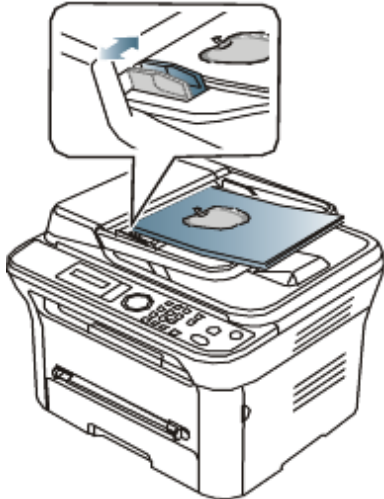

 Dust on the document feeder glass may cause black lines on the printout. Always keep the glass clean (See [Cleaning the scan unit](#)).

Selecting print media

You can print on a variety of print media, such as plain paper, envelopes, labels, and transparencies. Always use print media that meet the guidelines for use with your machine.

Guidelines to select the print media

Print media that does not meet the guidelines outlined in this user's guide may cause the following problems:

- Poor print quality
- Increased paper jams
- Premature wear on the machine.

Properties, such as weight, composition, grain, and moisture content, are important factors that affect the machine's performance and the output quality. When you choose print materials, consider the following:

- The type, size, and weight of the print media for your machine are described in print media specifications (See [Print media specifications](#)).
- Desired outcome: The print media you choose should be appropriate for your project.
- Brightness: Some print media are whiter than others and produce sharper, more vibrant images.
- Surface smoothness: The smoothness of the print media affects how crisp the printing looks on the paper.

-  • Some print media may meet all of the guidelines in this section and still not produce satisfactory results. This may be the result of improper handling, unacceptable temperature, and humidity levels, or other variables over which cannot be controlled.
- Before purchasing large quantities of print media, ensure that it meets the requirements specified in this user's guide.

 Using print media that does not meet these specifications may cause problems, requiring repairs. Such repairs are not covered by the warranty or service agreements.

The amount of paper put into the tray may differ according to media type used (See [Print media specifications](#)).

Media sizes supported in each mode

Mode	Size	Source
------	------	--------

Copy mode	Letter, A4, Legal, Oficio, Folio, Executive, ISO B5, JIS B5, A5, A6	<ul style="list-style-type: none"> • Tray 1 • Manual tray
Print mode	All sizes supported by the machine.	<ul style="list-style-type: none"> • Tray 1 • Manual tray
Fax mode	Letter, A4, Legal	<ul style="list-style-type: none"> • Tray 1

Changing the tray size

The tray is preset to Letter or A4 size, depending on your country. To change the size, you need to adjust the paper guides.

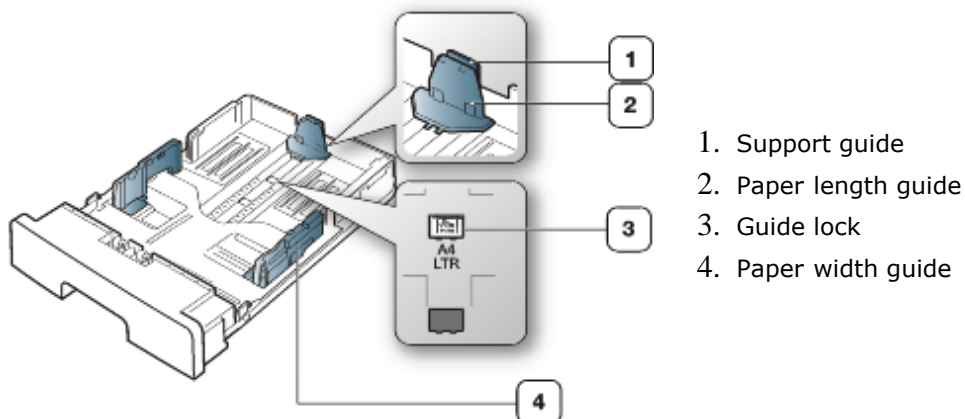

1. With one hand press and hold the guide lock, and with the other hand, hold the paper length guide and support guide together. Slide the paper length guide and support guide to locate them in the correct paper size slot.

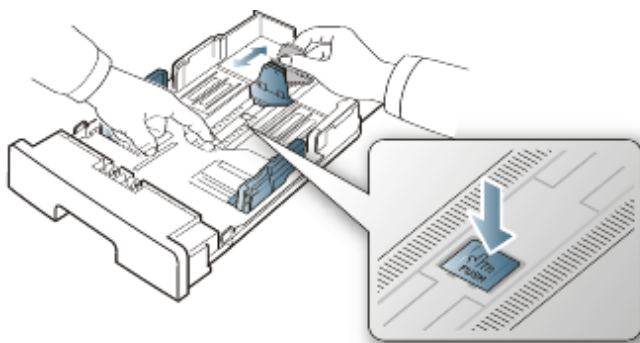

2. Flex or fan the edge of the paper stack to separate the pages before loading papers. Insert the paper into the tray.



3. After inserting paper into the tray, adjust the support guide so that it lightly touches the paper stack.

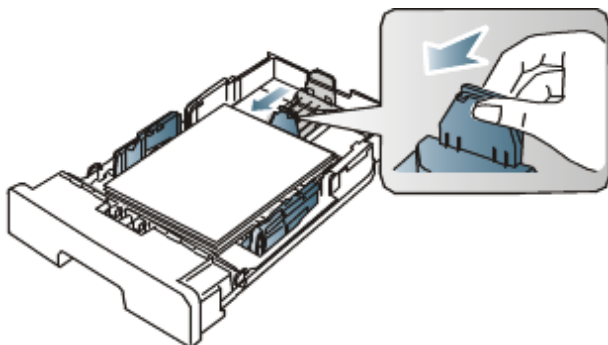

4. Squeeze the paper width guides and slide them to the desired paper size marked at the bottom of the tray.

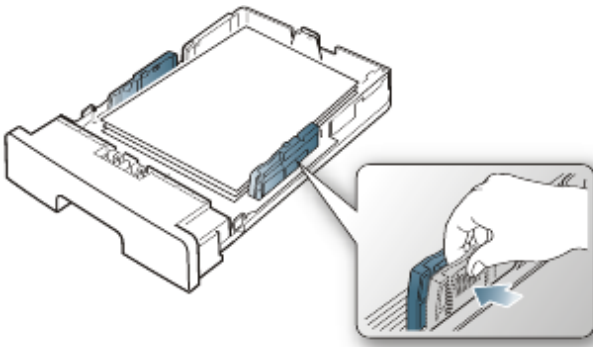

- Do not push the paper width guide too far causing the media to warp.
- If you do not adjust the paper width guide, it may cause paper jams.



- Do not use paper with more than 6 mm curl.

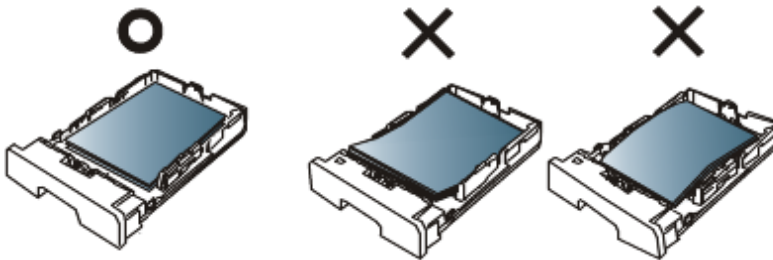

Loading paper in the tray

Tray 1

- Pull out the paper tray. And adjust the tray size to the media size you are loading (See [Changing the tray size](#)).
- Flex or fan the edge of the paper stack to separate the pages before loading paper.



- And place paper with the side you want to print facing down.

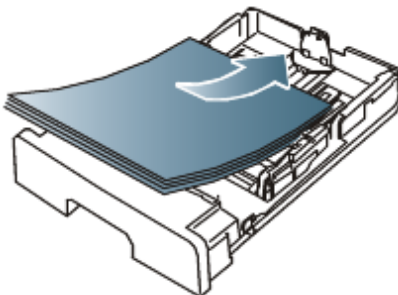

- Insert the tray back into the machine.
- When you print a document, set the paper type and size for the tray.
For information about setting the paper type and size (See [Setting the default tray and paper](#)).

- If you experience problems with paper feeding, check whether the paper meets the media specification. Then try placing one sheet at a time in the manual tray (See [Print media specifications](#)).

Manual tray

The manual tray can hold special sizes and types of print material, such as postcards, note cards, and envelopes. It is useful for single page printing on letterhead or colored paper.

Tips on using the manual tray

- If you select **Manual Feeder** for **Source** from your software application, you need to press **OK** each time you print a page and load only one type, size and weight of print media at a time in the manual tray.
 - To prevent paper jams, do not add paper while printing when there is still paper in the manual tray. This also applies to other types of print media.
 - Print media should be loaded face up with the top edge going into the manual tray first and be placed in the center of the tray.
 - Always load the specified print media only to avoid paper jams and print quality problems (See [Print media specifications](#)).
 - Flatten any curl on postcards, envelopes, and labels before loading them into the manual tray.
1. Load the paper in the manual tray.

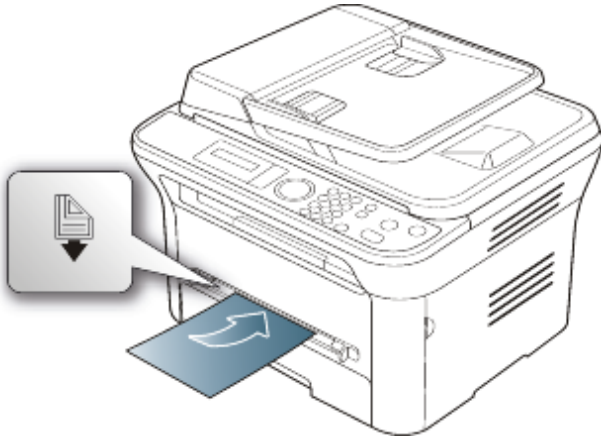

- Do not force the paper beyond the surface with  mark when loading.
 - When printing the special media, you must follow the loading guideline (See [Printing on special media](#)).
 - When papers overlap when printing using manual tray, open tray 1 and remove overlapping papers then try printing again.
 - When paper does not feed well while printing, push the paper in manually until it starts feeding automatically.
2. Squeeze the manual tray paper width guides and adjust them to the width of the paper. Do not force them too much, or the paper will bent resulting in a paper jam or skew.
 3. To print in application, open an application and start the print menu.
 4. Open **Printing Preferences** (See [Opening printing preferences](#)).
 5. Press the **Paper** tab in **Printing Preferences**, and select an appropriate paper type.
 - For example, if you want to use a label, set the paper type to **Label**.
 6. Select **Manual Feeder** in paper source, then press **OK**.
 7. Start printing in application.
- If you are printing multiple pages, load the next sheet after the first page prints out, and press the **OK**. Repeat this step for every page to be printed.

Printing on special media

The table below shows the available special media for each tray.

- When using special media, feed one paper at a time. Check the maximum input number of media for each tray (See [Print media specifications](#)).

Types	Tray 1	Manual tray
Plain	?	?
Thick	?	?
Thin	?	?
Bond		?
Color		?
CardStock		?
Labels		?

Transparency		?
Envelope		?
Preprinted		?
Cotton		?
Recycled	?	?
Archive	?	?

(?: supported, Blank: not supported)

The media types are shown in the **Printing Preferences**. This paper type option allows you to set the type of paper to be loaded in the tray. This setting appears in the list, so that you can select it. This will let you get the best quality printout. If not, the desired print quality may not be achieved.

- **Plain:** Normal plain paper. Select this type if your machine is monochrome and printing on the 60 to 90 g/m² (16 to 24 lb).
- **Thick:** 90 to 105 g/m² (24 to 28 lb) thick paper.
- **Thin:** 60 to 70 g/m² (16 to 19 lb) thin paper.
- **Bond:** 105 to 120 g/m² (28 to 32 lb) bond.
- **Color:** 75 to 90 g/m² (20 to 24 lb) color-backgrounded paper.
- **CardStock:** 90 to 163 g/m² (24 to 43 lb) cardstock.
- **Labels:** 120 to 150 g/m² (32 to 40 lb) labels.
- **Transparency:** 138 to 146 g/m² (37 to 39 lb) transparency paper.
- **Envelope:** 75 to 90 g/m² (20 to 24 lb) envelope.
- **Preprinted:** 75 to 90 g/m² (20 to 24 lb) preprinted/letterhead paper.
- **Cotton:** 75 to 90 g/m² (20 to 24 lb) cotton paper.
- **Recycled:** 75 to 90 g/m² (20 to 24 lb) recycled paper.

 When you use recycled paper as a used paper, printouts might be wrinkled.

- **Archive:** 70 to 90 g/m² (19 to 24 lb). If you need to keep the print-out for a long period time, such as archives, select this option.

Envelope

Successful printing on envelopes depends upon the quality of the envelopes.

To print an envelope, the stamp area is on the left side and the end of the envelope with the stamp area enters the printer first and the envelope in the center of the manual tray with the stamp area entering the printer first and keeping the stamp on the left.

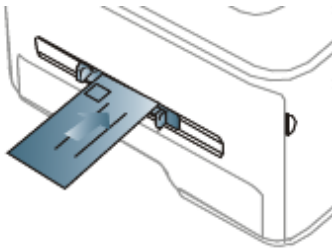

If envelopes are printed out with wrinkles, crease or black bold lines, open the rear cover and pull down the pressure lever and try printing again. Keep the rear cover opened during printing.

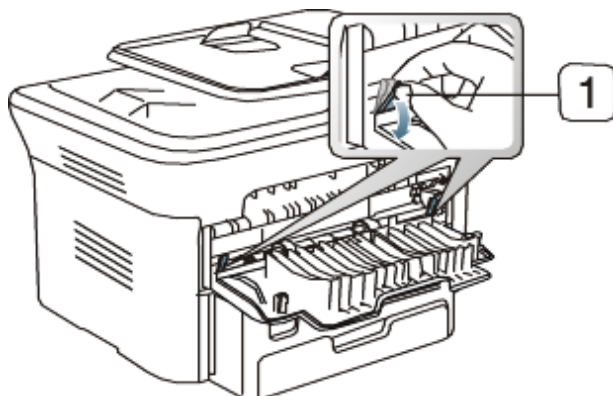

1. Pressure lever

- When selecting envelopes, consider the following factors:

- **Weight:** The weight of the envelope paper should not exceed 90 g/m² otherwise, jam may occur.
- **Construction:** Prior to printing, envelopes should lie flat with less than 6 mm curl, and should not contain air.
- **Condition:** Envelopes should not be wrinkled, nicked, nor damaged.
- **Temperature:** Use envelopes that are compatible with the heat and pressure of the machine during operation.
- Use only well-constructed envelopes with sharp-and well-creased folds.
- Do not use stamped envelopes.
- Do not use envelopes with clasps, snaps, windows, coated lining, self-adhesive seals, or other synthetic materials.
- Do not use damaged or poorly made envelopes.
- Be sure the seam at both ends of the envelope extends all the way to the corner of the envelope.

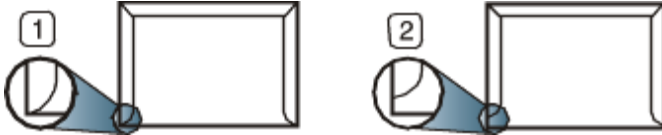

1. Acceptable
2. Unacceptable

- Envelopes with a peel-off adhesive strip or with more than one flap that folds over to seal, must use adhesives compatible with the machine's fusing temperature of about 170 °C (338 °F) for 0.1 second. The extra flaps and strips might cause wrinkling, creasing, or jams, and may even damage the fuser.
- For the best print quality, position margins no closer than 15 mm (0.59 inches) from the edges of the envelope.
- Avoid printing over the area where the envelope's seams meet.

Transparency

To avoid damaging the machine, use only transparencies designed for use in laser printers.

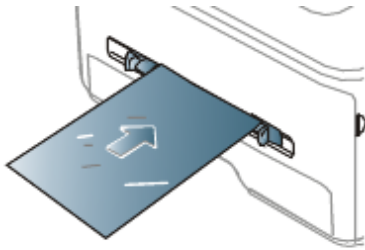

- Transparencies used in the machine must be able to withstand machine's fusing temperature.
- Place them on a flat surface after removing them from the machine.
- Do not leave unused transparencies in the paper tray for long periods of time. Dust and dirt may accumulate on them, resulting in spotty printing.
- To avoid smudging caused by fingerprints, handle them carefully.
- To avoid fading, do not expose printed transparencies to prolonged sunlight.
- Ensure that transparencies are not wrinkled, curled, or have any torn edges.
- Do not use transparencies that separates from the backing sheet.
- To prevent transparencies from sticking to each other, do not let the printed sheets stack up as they are being printed out.

Labels

To avoid damaging the machine, use only labels designed for use in laser machines.

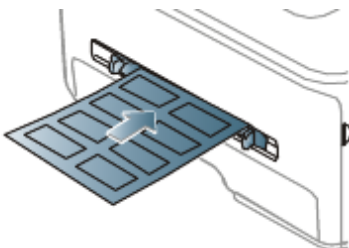

- When selecting labels, consider the following factors:
 - **Adhesives:** The adhesive material should be stable at your machine's fusing temperature about 170 °C (338

°F).

- **Arrangement:** Only use labels with no exposed backing between them. Labels can peel off sheets that have spaces between the labels, causing serious jams.
- **Curl:** Prior to printing, labels must lie flat with no more than 13 mm of curl in any direction.
- **Condition:** Do not use labels with wrinkles, bubbles, or other indications of separation.
- Make sure that there is no exposed adhesive material between labels. Exposed areas can cause labels to peel off during printing, which can cause paper jams. Exposed adhesive can also cause damage to machine components.
- Do not run a sheet of labels through the machine more than once. The adhesive backing is designed for only a single pass through the machine.
- Do not use labels that are separating from the backing sheet or are wrinkled, bubbled, or otherwise damaged.

Card stock/Custom-sized paper

Postcards, cards, and other custom-sized materials can be printed with this machine.

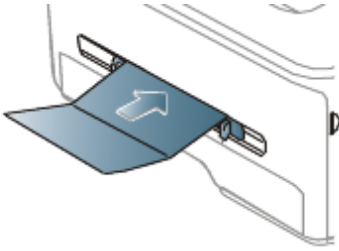

- Do not print on media smaller than 76 mm (3.00 inches) wide or 127 mm (5.00 inches) long.
- In the software application, set margins at least 6.4 mm (0.25 inches) away from the edges of the material.
- If media weight is over 160 g/m² (43 lb), try printing in the rear cover (face up).

Letterhead/ Preprinted paper

	Single-sided	Double-sided
Tray1	Face down 	Face up
Manual tray	Face up 	Face down

- Letterhead/ Preprinted paper must be printed with heat-resistant ink that will not melt, vaporize, or release hazardous emissions when subjected to the machine's fusing temperature for 0.1 second. Check your machine's specification to view the fusing temperature about 170°C(338 °F).
- Letterhead/ Preprinted paper ink must be non-flammable and should not adversely affect machine rollers.
- Forms and letterhead should be sealed in a moisture-proof wrapping to prevent changes during storage.
- Before you load letterhead/preprinted paper, verify that the ink on the paper is dry. During the fusing process, wet ink can come off preprinted paper, reducing print quality.

Photo

- Make sure not to use the inkjet photo paper with this machine. It could cause damage to the machine.

Glossy



- ☞ Load one paper to the manual tray at a time, glossy side facing up.

Setting the paper size and type

After loading paper in the paper tray, set the paper size and type using the control panel. These settings will apply to copy and fax modes. For computer printing, select the paper size and type in the application program you use on your computer (See [Opening printing preferences](#)).



 The settings made from the machine driver override the settings on the control panel.

Setting the paper size



1. Press **Menu** () on the control panel.
2. Press the left/right arrow until **System Setup** appears and press **OK**.
3. Press the left/right arrow until **Paper Setup** appears and press **OK**.
4. Press the left/right arrow until **Paper Size** appears and press **OK**.
5. Press the left/right arrow to select the paper tray you want and press **OK**.
6. Press the left/right arrow to select the paper size you want.
7. Press **OK** to save the selection.
8. Press **Stop/Clear** () to return to ready mode.

 If you want to use special-sized paper, such as a billing paper, select **Edit...** in the **Paper** tab in the **Printing Preferences** (See [Opening printing preferences](#)).

Setting the paper type

1. Press **Menu** () on the control panel.
2. Press the left/right arrow until **System Setup** appears and press **OK**.
3. Press the left/right arrow until **Paper Setup** appears and press **OK**.
4. Press the left/right arrow until **Paper Type** appears and press **OK**.
5. Press the left/right arrow to select the paper tray you want and press **OK**.
6. Press the left/right arrow to select the paper type you want.
7. Press **OK** to save the selection.
8. Press **Stop/Clear** () to return to ready mode.

Setting the paper source

1. Press **Menu** () on the control panel.
2. Press the left/right arrow until **System Setup** appears and press **OK**.
3. Press the left/right arrow until **Paper Setup** appears and press **OK**.
4. Press the left/right arrow until **Paper Source** appears and press **OK**.
5. Press the left/right arrow until **Copy Tray** or **Fax Tray** appears and press **OK**.
6. Press the left/right arrow to select the paper tray you want.
7. Press **OK** to save the selection.
8. Press **Stop/Clear** () to return to ready mode.

Using the output support

 The surface of the output tray may become hot if you print a large number of pages at once. Make sure that you do not touch the surface, and do not allow children near it.

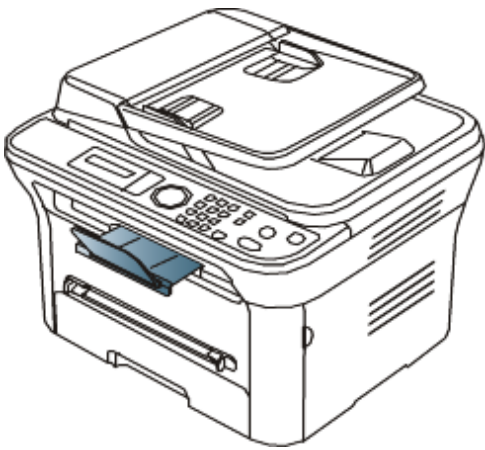

The printed pages stack on the output support, and the output support will help the printed pages to align. The printer sends output to the output tray by default. To use the output tray, make sure that the rear cover is closed.



 If you are using A5 paper, fold the output tray. Otherwise, printed pages might be mis-aligned or jammed.

Stacking papers firmly

If you use the machine in a humid area, or you are using the damp print media caused by a use a print media that is damp because of high humidity, the print-outs on the output tray may be curled and may not be stacked properly. In this case, you can set the machine to use the **Paper Stacking** function to let print-outs be stacked firmly. But, using this function will make the print speed slow.

1. Press **Menu** () on the control panel.
2. Press the left/right arrow until **System Setup** appears and press **OK**.
3. Press the left/right arrow until **Maintenance** appears and press **OK**.
4. Press the left/right arrow until **Paper Stacking** appears and press **OK**.
5. Press the left/right arrow until **On** appears and press **OK**.
6. Press **Stop/Clear** () to return to ready mode.

Getting a small-sized printout

When you have printed a small sized printout like an envelope or a custom sized printout, it may not be placed on the output support, due to its small size.

In this case, get the printout pull up the scan unit, get the printout, and close the scan unit again for future use.

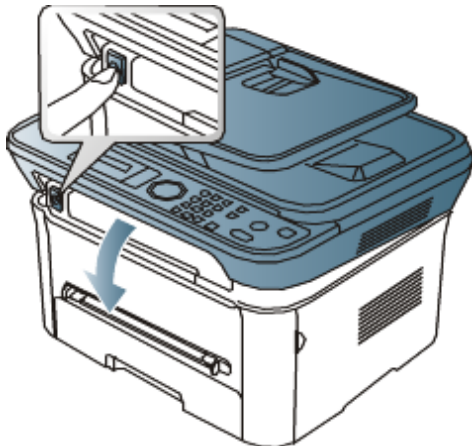
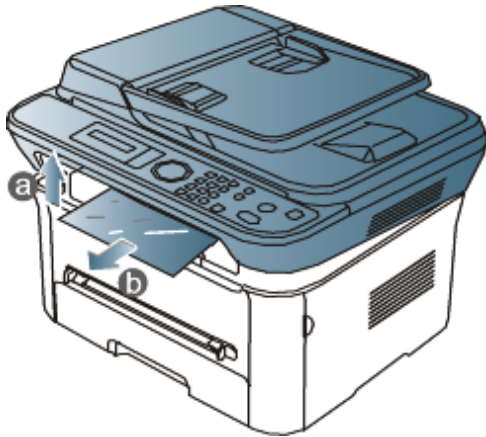

Network setup

This chapter gives you step-by-step instructions for setting up the network connected machine and software.

This chapter includes:

- [Network environment](#)
- [Introducing useful network programs](#)
- [Using a wired network](#)
- [Installing network connected machine's driver](#)
- [IPv6 Configuration](#)

Network environment

You need to set up the network protocols on the machine to use it as your network machine. You can set up the basic network settings through the machine's control panel.

The following table shows the network environments supported by the machine:

Item	Requirements
Network interface	<ul style="list-style-type: none">• Ethernet 10/100 Base-TX
Network operating system	<ul style="list-style-type: none">• Windows 2000/XP/2003/2008/Vista/7/2008 Server R2• Various Linux OS• Mac OS X 10.3 ~ 10.6
Network protocols	<ul style="list-style-type: none">• TCP/IPv4• DHCP, BOOTP• DNS, WINS, Bonjour, SLP, UPnP• Standard TCP/IP Printing(RAW), LPR, IPP• SNMPv 1/2/3, HTTP(S), IPsec• TCP/IPv6 (DHCP, DNS, RAW, LPR, SNMPv 1/2/3, HTTP(S), IPsec) (See IPv6 Configuration).

Introducing useful network programs

There are several programs available to setup the network settings easily in network environment. For the network administrator especially, managing several machines on the network is possible.

 Before using the programs below, set the IP address first.

Embedded Web Service

Web server Embedded on your network machine, which allows you to:

- Configure the network parameters necessary for the machine to connect to various network environments.
- Customize machine settings.

(See [Using Embedded Web Service](#)).

SetIP

This utility program allows you to select a network interface and manually configure the IP addresses for use with the TCP/IP protocol (See [IP setting using SetIP Program \(Windows\)](#) or [IP setting using SetIP Program \(Macintosh\)](#)).

 TCP/IPv6 is not supported by this program.

Using a wired network

You must set up the network protocols on your machine to use it on your network. This chapter will show you how this is easily accomplished.

You can use network after connecting network cable to a corresponding port on your machine.

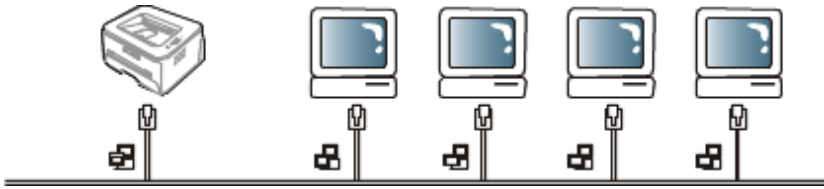

Printing Network Configuration report

You can print a **Network Configuration Report** from the machine's control panel that will show the current machine's network settings. This will help you to set up a network and troubleshoot problems.

1. Press **Menu** (📄) on the control panel.
2. Press the left/right arrow until **Network** appears and press **OK**.
3. Press the left/right arrow until **Network Info.** appears and press **OK**.
4. Press the left/right arrow until **Yes** appears and press **OK**.

Using this **Network Configuration Report**, you can find your machine MAC address and IP address.

For example:

- MAC Address:00:15:99:41:A2:78
- IP Address:192.0.0.192

Setting IP address

First, you have to set up an IP address for network printing and managements. In most cases a new IP address will be automatically assigned by a DHCP (Dynamic Host Configuration Protocol) server located on the network.

In a few situations the IP address must be set manually. This is called a static IP and is often required in corporate Intranets for security reasons.

- **DHCP IP assignment:** Connect your machine to the network, and wait a few minutes for the DHCP server to assign an IP address to the machine. Then, print the **Network Configuration Report** as explained above. If the report shows that the IP address has changed, the assignment was successful. You will see the new IP address in the report.
- **Static IP assignment:** Use SetIP program to change the IP address from your computer. If your machine has a control panel, you can also change IP address using the machine's control panel.

In an office environment, we recommend that you contact a network administrator to set this address for you.

IP setting using control panel

1. Connect your machine to the network with a network cable.
2. Turn on the machine.
3. Press **Menu** (📄) on the control panel.
4. Press the left/right arrow until **Network** appears and press **OK**.
5. Press the left/right arrow until **TCP/IP (IPv4)** appears and press **OK**.
6. Press the left/right arrow until **Static** appears and press **OK**.
7. Press the left/right arrow until **IP Address** appears and press **OK**.
8. Enter the IP address using numeric keypad and press **OK**.

🖋 Enter a byte between 0 and 255 using the number keypad and press the left/right arrow to move between bytes.

Repeat this to complete the address from the 1st byte to the 4th byte.

9. Enter other parameters, such as the **Subnet Mask** and **Gateway** appears and press **OK**.

10. After entering all parameters, press **Stop/Clear** to return to ready mode.

Now go to [Installing network connected machine's driver](#).

IP setting using SetIP Program (Windows)

This program is for manually setting the network IP address of your machine using its MAC address to communicate with the machine. A MAC address is the hardware serial number of the network interface and can be found in the **Network Configuration Report**.

For using SetIP program, disable the computer firewall before continuing by performing the following:

1. Open **Control Panel**.
2. Double click **Security Center**.
3. Click **Windows Firewall**.
4. Disable the firewall.

Installing the program

1. Insert the Printer Software CD-ROM provided with your machine. When the driver CD runs automatically, close that window.
2. Start Windows Explorer and open the X drive (X represents your CD-ROM drive).
3. Double-click **Application > SetIP**.
4. Double-click **Setup.exe** to install this program.
5. Select a language, then click **Next**.
6. Follow the instructions in the window and complete the installation.

Starting the program

1. Connect your machine to the network with a network cable.
2. Turn on the machine.
3. From the Windows **Start** menu, select **All Programs > Dell Printers > SetIP > SetIP**.
4. Click on the  icon (third from left) in the SetIP window to open the TCP/IP configuration window.
5. Enter the machine's new information into the configuration window as follows. In a corporate intranet, you may need to have this information assigned by a network manager before proceeding.

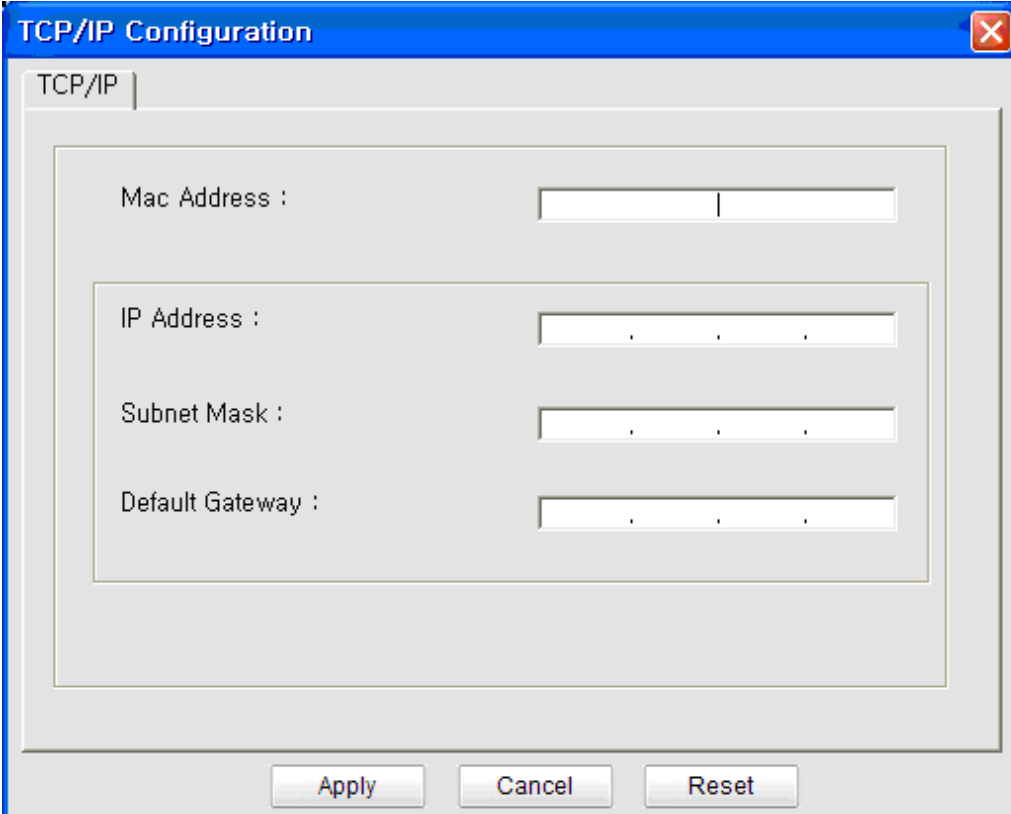

- **MAC Address:** Find the machine's MAC address from the **Network Configuration Report** and enter it without the colons. For example, 00:15:99:29:51:A8 becomes 0015992951A8.
 - **IP Address:** Enter a new IP address for your printer.
For example, if your computer's IP address is 192.168.1.150, enter 192.168.1.X (X is number between 1 and 254 other than the computer's address).
 - **Subnet Mask:** Enter a Subnet Mask.
 - **Default Gateway:** Enter a Default Gateway.
6. Click **Apply**, and then click **OK**. The machine will automatically print the **Network Configuration Report**. Confirm that all the settings are correct.
 7. Click **Exit** to close the SetIP program.
 8. If necessary, restart the computer's firewall.

IP setting using SetIP Program (Macintosh)

For using SetIP program, disable the computer firewall before continuing by performing the following:

1. Open **System Preferences**.
2. Click **Security**.
3. Click the **Firewall** menu.
4. Turn firewall off.

 The following instructions may vary for your model.

1. Connect your machine to the network with a network cable.
2. Insert the Installation CD-ROM, and open the disk window, select **MAC_Installer > MAC_Printer > SetIP > SetIPApplet.html**.
3. Double click the file and **Safari** will automatically open, then select **Trust**. The browser will open the **SetIPApplet.html** page that shows the printer's name and IP address information.
4. Highlight the printer information row and select the **Setup icon**, which is the second icon from the left in the application menu bar. A TCP/IP Configuration window will open.

 If the printer was not shown in the information row, select the Manual Setting icon (third from left) to open the TCP/IP Configuration window.

5. Enter the machine's new information into the configuration window as follows. In a corporate intranet, you may need to have this information assigned by a network manager before proceeding.
 - **MAC Address:** Find the machine's MAC address from the **Network Configuration Report** and enter it without the colons. For example, 00:15:99:29:51:A8 becomes 0015992951A8.
 - **IP Address:** Enter a new IP address for your printer.
For example, if your computer's IP address is 192.168.1.150, enter 192.168.1.X (X is number between 1 and 254 other than the computer's address).
 - **Subnet Mask:** Enter a Subnet Mask.
 - **Default Gateway:** Enter a Default Gateway.
6. Select **Apply**, then **OK**, and **OK** again. The printer will automatically print the configuration report. Confirm that all the settings are correct. **Quit Safari**. You may close and eject the installation CD-ROM. If necessary, restart the computer's firewall. You have successfully changed the IP address, subnet mask, and gateway.

IP setting using SetIP Program (Linux)

SetIP program should be automatically installed during the printer driver installation.

1. Print the machine's network configuration report to find your machine's MAC address.
2. Open the `/opt/Dell/mfp/share/utils/`.
3. Double click the **SetIPApplet.html** file.
4. Click to open the TCP/IP configuration window.
5. Enter the network card's MAC address, IP address, subnet mask, default gateway, and then click **Apply**.

 When you enter the MAC address, enter it without a colon(:).

6. The machine prints the network information. Confirm all the settings are correct.
7. Close the SetIP program.

Network parameter setting

You can also set up the various network settings through the network administration programs such as **Embedded Web Service**.

Restoring factory default settings

You may need to reset the machine to the factory default settings when machine that you are using is connected to new network environment.

Restoring factory default settings using control panel

1. Press **Menu** () on the control panel.
2. Press the left/right arrow until **Network** appears and press **OK**.
3. Press the left/right arrow until **Clear Settings** appears and press **OK**.
4. Turn off and restart machine to apply settings.

Restoring factory default settings using Embedded Web Service

1. Start a web browser such as Internet Explorer, Safari or Firefox and enter your machine's new IP address in the browser window.

For example,

 `http://192.168.1.133/`

2. When the **Embedded Web Service** window opens, click **Network Settings**.
3. Click **Reset**. Then, click **Clear** for network.
4. Turn off and restart machine to apply settings.

Installing network connected machine's driver

Windows

You can set up the machine driver, follow the steps below.

This is recommended for most users. All components necessary for machine operations will be installed.

1. Make sure that the machine is connected to the network and powered on.
2. Insert the supplied software CD into your CD/DVD drive.
 - The software CD should automatically run and an installation window appear.
 - If the installation window does not appear, click **Start** and then **Run**. Type X:\Setup.exe, replacing "X" with the letter which represents your drive. Click **OK**.
 - If you use Windows Vista, Windows 7 and Windows 2008 Server R2 click **Start > All programs > Accessories > Run**. Type X:\Setup.exe replacing "X" with the letter which represents your drive and click **OK**.
 - If the **AutoPlay** window appears in Windows Vista, Windows 7 and Windows 2008 Server R2, click **Run Setup.exe** in **Install or run program** field, and click **Continue** or **Yes** in the **User Account Control** windows.
3. Click **Next**.

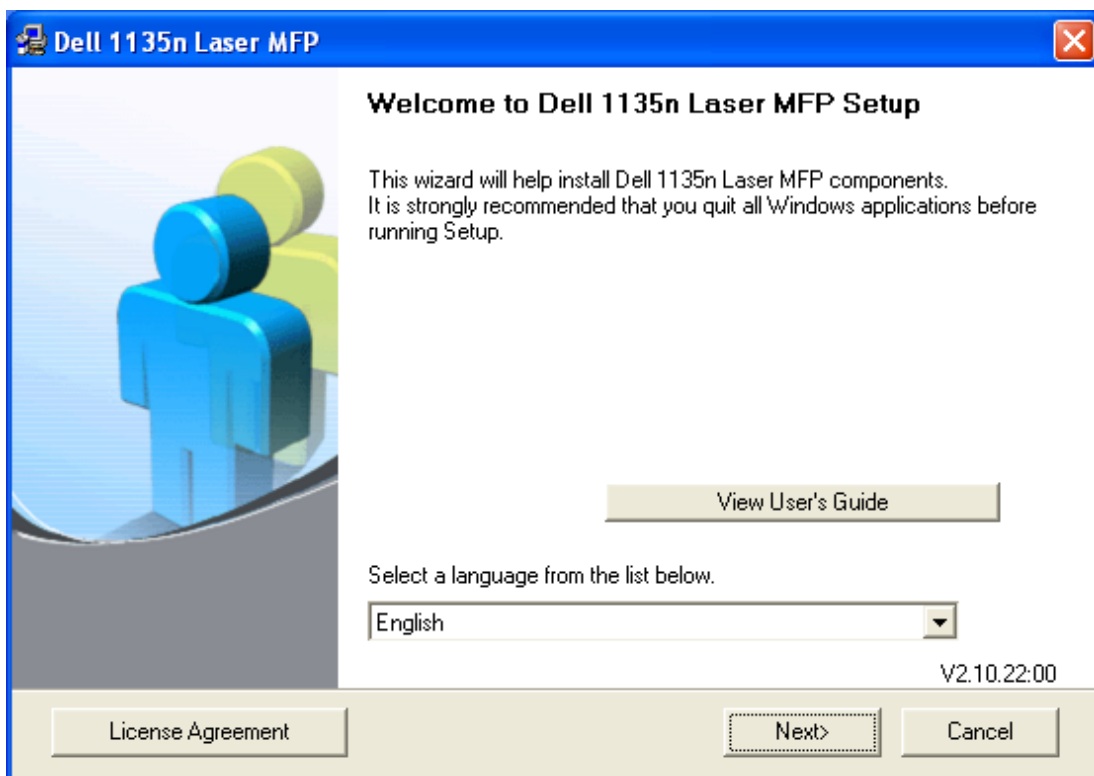

If necessary, select a language from the drop-down list.

4. Select **Typical installation for a network printer**. Then, click **Next**.
 - The Custom Installation allows you to select the machine's connection and choose individual component to install. Follow the guide on the window.

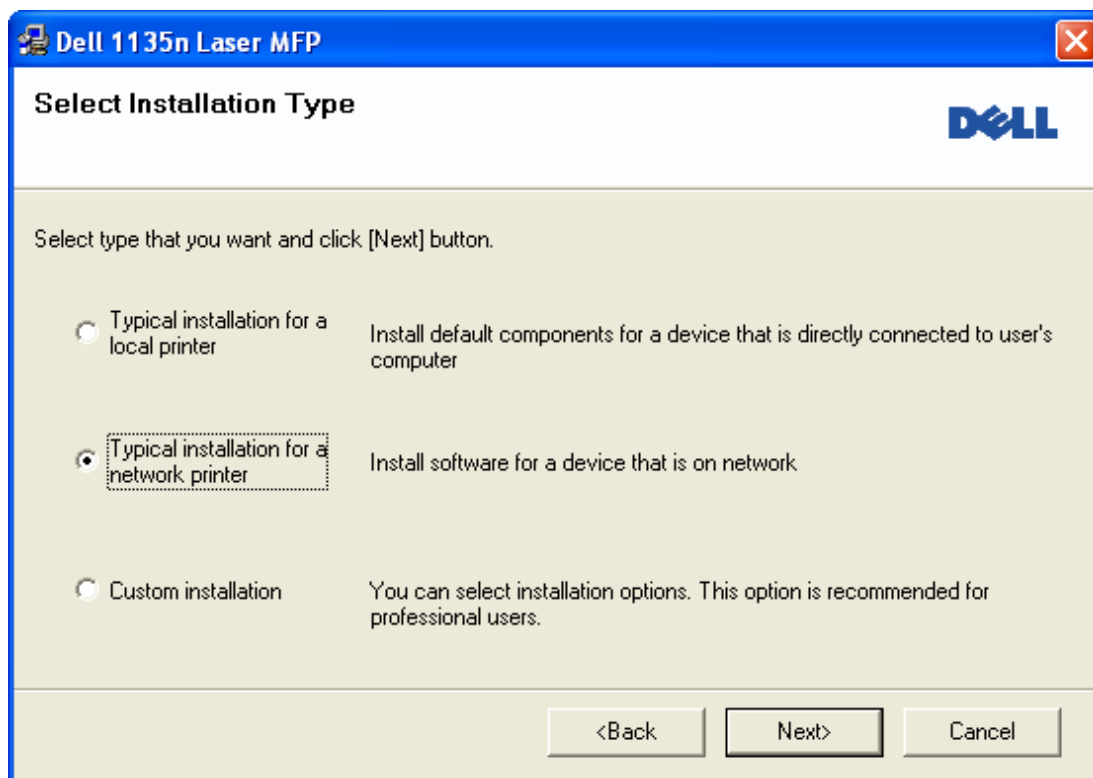

5. The list of printers available on the network appears. Select the printer you want to install from the list and then click **Next**.

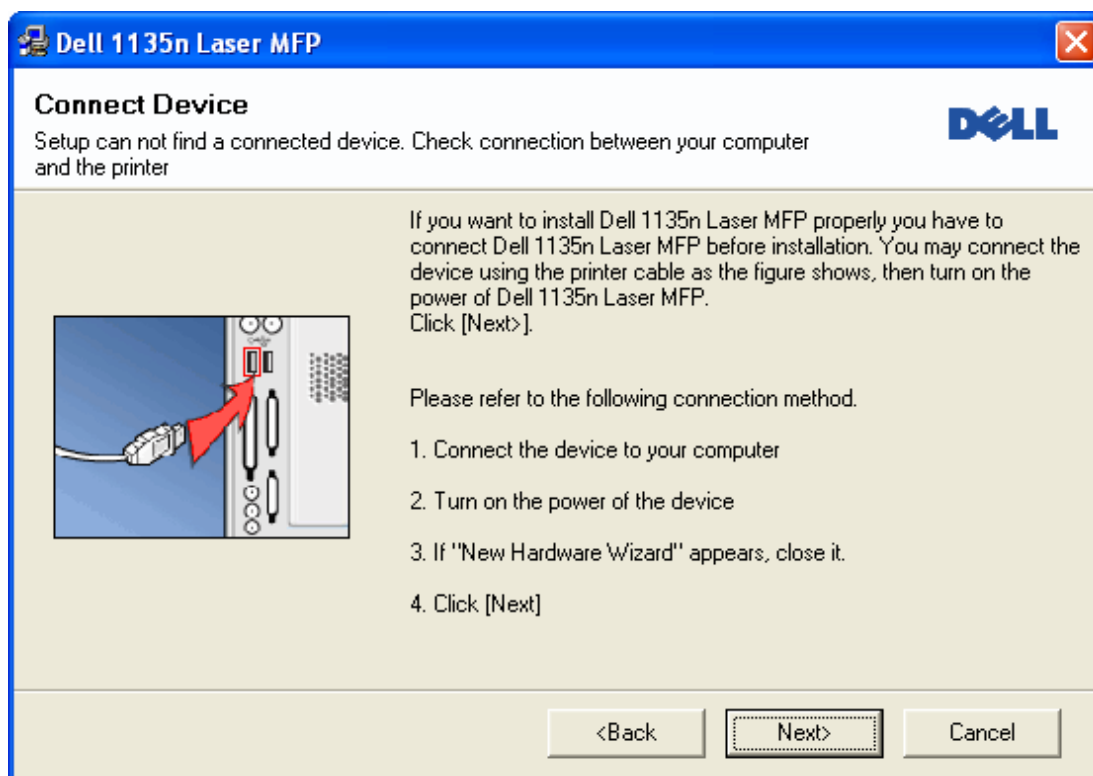

- If you do not see your printer on the list, click **Update** to refresh the list, or select **Add TCP/IP Port** to add your printer to the network. To add the printer to the network, enter the port name and the IP address for the printer.
- To verify your printer's IP address, print a Network Configuration page. (By pressing the **Stop/Clear** (⊘) for about 5 seconds, then release. (Example IP Address is 13.121.52.104)
- To find a shared network printer (UNC Path), select **Shared Printer [UNC]** and enter the shared name manually or find a shared printer by clicking the **Browse** button.
- ☞ If you cannot find your machine in network, please turn off the firewall and click **Update**. For Windows operating system, **Start > Control Panel** and start windows firewall, and deactivate this option. For other operating system, refer to its on-line guide.

6. After the installation is finished, a window asking you to print a test page appears. If you choose to print a test page, select the checkbox and click **Next**. Otherwise, just click **Next** and skip to step 8.

7. If the test page prints out correctly, click **Yes**.
If not, click **No** to reprint it.
 8. Click **Finish**.
-  • After the driver setup, you may enable firewall.
- If the printer driver does not work properly, follow the steps below to repair or reinstall the driver.
 1. Make sure that the machine is connected to your machine and powered on.
 2. From the **Start** menu, select **Programs** or **All Programs** > **Dell** > **Dell Printers** > **your printer driver name** > **Maintenance**.
 3. Select the option as you wish, follow the instruction on the window.

Macintosh

1. Make sure that the machine is connected to your network and powered on. Also, your machine's IP address should have been set.
2. Insert the supplied software CD into your CD/DVD drive.
3. Double-click the CD-ROM icon that appears on your Macintosh desktop.
4. Double-click the **MAC_Installer** folder.
5. Double-click the **Installer OS X** icon.
6. Enter the password and click **OK**.
7. The **Dell Installer** window opens. Click **Continue**.
8. Select **Easy Install** and click **Install**. **Easy Install** is recommended for most users. All components necessary for machine operations will be installed.
 - If you select **Custom Install**, you can choose individual components to install.
9. The message which warns that all applications will close on your computer appears. Click **Continue**.
10. After the installation is finished, click **Quit**.
11. Open the **Applications** folder > **Utilities** > **Print Setup Utility**.
 - For Mac OS X 10.5~10.6, open the **Applications** folder > **System Preferences** and click **Print & Fax**.
12. Click **Add** on the **Printer List**.
 - For Mac OS X 10.5~10.6, click the "+" icon; a display window will pop up.
13. For Mac OS X 10.3, select the **IP Printing** tab.
 - For Mac OS X 10.4, click **IP Printer**.
 - For Mac OS X 10.5~10.6, click **IP**.
14. Select **Socket/HP Jet Direct** in **Printer Type**.

 When printing a document containing many pages, printing performance may be enhanced by choosing **Socket for Printer Type** option.
15. Enter the machine's IP address in the **Printer Address** field.
16. Enter the queue name in the **Queue Name** field. If you cannot determine the queue name for your machine server, try using the default queue first.
17. For Mac OS X 10.3, if Auto Select does not work properly, select **Dell** in **Printer Model** and your machine name in **Model Name**.
 - For Mac OS X 10.4, if Auto Select does not work properly, select **Dell** in **Print Using** and your machine name in **Model**.
 - For Mac OS X 10.5~10.6, if Auto Select does not work properly, select **Select a driver to use...** and your machine name in **Print Using**.

Your machine appears on the **Printer List**, and is set as the default machine.
18. Click **Add**.

 If the printer driver does not work properly, uninstall the driver and reinstall it. Follow steps below to uninstall the driver for Macintosh.

 1. Make sure that the machine is connected to your computer and powered on.
 2. Insert the supplied software CD into your CD/DVD drive.
 3. Double-click CD-ROM icon that appears on your Macintosh desktop.
 4. Double-click the **MAC_Installer** folder.
 5. Double-click the **Installer OS X** icon.
 6. Enter the password and click **OK**.
 7. The Dell Installer window opens. Click **Continue**.

8. Select **Uninstall** and click **Uninstall**.
9. When the message which warns that all applications will close on your computer appears, Click **Continue**.
10. When the uninstall is done, click **Quit**.

Linux

Install Linux Driver

1. Make sure that the machine is connected to your network and powered on. Also, your machine's IP address should have been set.
2. Insert the supplied software CD into your CD/DVD drive.
3. Double-click CD-ROM icon that appears on your Linux desktop.
4. Double-click the **Linux** folder.
5. Double-click the **install.sh** icon.
6. The **Dell Installer** window opens. Click **Continue**.
7. The Add printer wizard window opens. Click **Next**.
8. Select Network printer and click **Search** button.
9. The Printer's IP address and model name appears on list field.
10. Select your machine and click **Next**.

Add network Printer

1. Double-click the **Unified Driver Configurator**.
2. Click **Add Printer...**
3. The **Add printer wizard** window opens. Click **Next**.
4. Select **Network printer** and click the **Search** button.
5. The printer's IP address and model name appears on list field.
6. Select your machine and click **Next**.
7. Input the printer description and **Next**
8. When the add printer is done, click **Finish**.



IPv6 Configuration

 **TCP/IPv6** is supported properly only in Windows Vista or higher.

 If the IPv6 network seems to not be working, set all the network setting to the factory defaults and try again (See [Restoring factory default settings](#)).

To use the IPv6 network environment, follow the next procedure to use the IPv6 address:

1. Connect your machine to the network with a network cable.
2. Turn on the machine.
3. Print a **Network Configuration Report** from the machine's control panel that will check IPv6 addresses.

-  1. Press **Menu** () on the control panel.
2. Press the left/right arrow until **Network** appears and press **OK**.
3. Press the left/right arrow until **Network Info**. appears and press **OK**.
4. Press the left/right arrow until **Yes** appears and press **OK**.

4. Select **Start > Control Panel > Hardware and Sound > Printers > Add Printer**.
5. Click **Add a local printer** on the **Add Printer** windows.
6. Follow the instruction on the window.

 If the machine does not work in the network environment, activate IPv6. Refer to the next section followed by.

Activating IPv6

The machine is provided with IPv6 feature on.

1. Press **Menu** () on the control panel.
2. Press the left/right arrow until **Network** appears and press **OK**.
3. Press the left/right arrow until **TCP/IP (IPv6)** appears and press **OK**.
4. Press the left/right arrow until **IPv6 Activate** appears and press **OK**.
Press the left/right arrow until **On** appears and press **OK**.

- 5.
6. Turn the machine off and turn it on again.
7. Reinstall your printer driver.

Setting IPv6 addresses

Machine supports following IPv6 addresses for network printing and managements.

- **Link-local Address:** Self-configured local IPv6 address (Address starts with FE80).
- **Stateless Address:** Automatically configured IPv6 address by a network router.
- **Stateful Address:** IPv6 address configured by a DHCPv6 server.
- **Manual Address:** Manually configured IPv6 address by a user.

DHCPv6 address configuration (Stateful)

If you have a DHCPv6 server on your network, you can set one of the following option for default dynamic host configuration:

1. Press **Menu** () on the control panel.
2. Press the left/right arrow until **Network** appears and press **OK**.
3. Press the left/right arrow until **TCP/IP (IPv6)** appears and press **OK**.
4. Press the left/right arrow until **DHCPv6 Config** appears and press **OK**.
5. Press the left/right arrow to access the required value.
 - **Router:** Use DHCPv6 only when requested by a router.
 - **DHCPv6 Addr.:** Always use DHCPv6 regardless of router request.
 - **DHCPv6 Off:** Never use DHCPv6 regardless of router request.
6. Press **OK**.

Manual address configuration

1. Start a web browser such as Internet Explorer that supports IPv6 addressing as a URL (See [Connecting Embedded Web Service](#)).
 -  For IPv4, enter the IPv4 address (http://xxx.xxx.xxx.xxx) in the address field and press the Enter key or click **Go**.
2. When the **Embedded Web Service** window opens, click **Network Settings**.
3. Click **TCP/IP**.
4. Enable the **Manual Address** In the **TCP/IPv6** section.
5. Select the **Router Prefix** and click the **Add** button, then the router prefix will automatically be entered into the address field.

Enter the rest of address (ex:3FFE:10:88:194::AAAA. "A" is the hexadecimal 0 through 9, A through F).
6. Click the **Apply** button.

Connecting Embedded Web Service

1. Start a web browser such as Internet Explorer that supports IPv6 addressing as a URL.
2. Select one of the IPv6 addresses (**Link-local Address**, **Stateless Address**, **Stateful Address**, **Manual Address**) from **Network Configuration Report**.
3. Enter the IPv6 addresses (ex: http://[FE80::215:99FF:FE66:7701]).

 Address must be enclosed in '[']' brackets.

Specifications

This chapter include:

- [Hardware specifications](#)
- [Environmental specifications](#)
- [Electrical specifications](#)
- [Print media specifications](#)

 The specification values are listed below, specification are subject to change without notice. See www.dell.com or support.dell.com/manuals for possible changes in information.

Hardware specifications

Item		Description
Dimensions	Height	318.9 mm (12.6 inches)
	Depth	415.4 mm (16.4 inches)
	Width	416 mm (16.4 inches)
Weight	Machine with consumables	11.55 Kg (25.46 lbs)
Package weight	Paper	2.29 Kg (5.05 lbs)
	Plastic	0.49 Kg (1.07 lbs)

Environmental specifications

Item		Description
Noise Level ^[a]	Ready mode	26 dB(A)
	Printing mode	50 dB(A)
	Copying mode (scanner glass)	50 dB(A)
	Copying mode (document feeder)	52 dB(A)
Temperature	Operation	10 to 32 °C (50 to 90 °F)
	Storage (unpacked)	0 to 40 °C (32 to 104 °F)
Humidity	Operation	20 to 80% RH
	Storage (unpacked)	10 to 80% RH

^[a] Sound Pressure Level, ISO 7779. Configuration tested: machine basic installation, A4 paper, simplex printing.

Electrical specifications

 Power requirements are based on the country/region where the device is sold. Do not convert operating voltages. Doing so might damage the device and void the product warranty.

Item		Description
Power rating ^[a]	110 volt models	AC 110 - 127 V
	220 volt models	AC 220 - 240 V
Power consumption	Average operating mode	Less than 370 W
	Ready mode	Less than 45 W
	Power save mode	Less than 10 W
	Power off mode	Less than 1 W

^[a] See the rating label on the machine for the correct voltage, frequency (hertz) and type of current for your machine.

Print media specifications

Type	Size	Dimensions	Print media weight ^[a] / Capacity ^[b]	
			Tray1	Manual tray
Plain paper	Letter	216 x 279 mm (8.50 x 11.00 inches)	60 to 120 g/m ² (16 to 32 lb bond) <ul style="list-style-type: none"> • 250 sheets of 80g/m² (20 lb bond) 	60 to 163 g/m ² (16 to 43 lb bond) <ul style="list-style-type: none"> • 1 sheet stacking
	Legal	216 x 356 mm (8.50 x 14.00 inches)		
	US Folio	216 x 330 mm (8.50 x 13.00 inches)		
	A4	210 x 297 mm (8.27 x 11.69 inches)		
	Oficio	216 x 343 mm (8.50 x 13.50 inches)		
	JIS B5	182 x 257 mm (7.17 x 10.12 inches)	60 to 90 g/m ² (16 to 24 lb bond) <ul style="list-style-type: none"> • 150 sheets of 80 g/m² (20 lb bond) 	
	ISO B5	176 x 250 mm (6.93 x 9.84 inches)		
	Executive	184 x 267 mm (7.25 x 10.50 inches)		
	A5	148 x 210 mm (5.83 x 8.27 inches)		
	A6	105 x 148 mm (4.13 x 5.83 inches)		
Envelope	Envelope Monarch	98 x 191 mm (3.87 x 7.50 inches)	Not available in tray1	75 to 90 g/m ² (20 to 24 lb bond) <ul style="list-style-type: none"> • 1 sheet stacking
	Envelope No. 10	105 x 241 mm (4.12 x 9.50 inches)		
	Envelope DL	110 x 220 mm (4.33 x 8.66 inches)		
	Envelope C5	162 x 229 mm (6.38 x 9.02 inches)		
	Envelope C6	114 x 162 mm (4.49 x 6.38 inches)		
Thick paper	Refer to the Plain paper section	Refer to the Plain paper section	90 g/m ² (24 lb bond)	90 g/m ² (24 lb bond) <ul style="list-style-type: none"> • 1 sheet stacking
Thin paper	Refer to the Plain paper section	Refer to the Plain paper section	60 to 70 g/m ² (16 to 19 lb bond)	60 to 70 g/m ² (16 to 19 lb bond) <ul style="list-style-type: none"> • 1 sheet stacking
Transparency	Refer to the Plain paper section	Refer to the Plain paper section	Not available in tray1	138 to 146 g/m ² (36.81 to 38.91 lb)

				bond) • 1 sheet stacking
Labels ^[c]	Letter, Legal, US Folio, A4, JIS B5, ISO B5, Executive, A5, Statement	Refer to the Plain paper section	Not available in tray1	120 to 150 g/m ² (32 to 40 lb bond) • 1 sheet stacking
Card stock	Letter, Legal, US Folio, A4, JIS B5, ISO B5, Executive, A5, Statement, PostCard 4x6	Refer to the Plain paper section	Not available in tray1	105 to 163 g/m ² (28 to 43 lb bond) • 1 sheet stacking
Minimum size (custom)		76 x 127 mm (3.00 x 5.00 inches)	60 to 163 g/m ² (16 to 43 lb bond)	
Maximum size (custom)		216 x 356 mm (8.50 x 14.02 inches)		

^[a] If media weight is over 120 g/m² (32 lb), load a paper into the tray one by one.

^[b] Maximum capacity may differ depending on media weight, thickness, and environmental conditions.

^[c] Smoothness: 100 to 250 (sheffield).

Supplies and accessories

This chapter provides information on purchasing supplies, accessories and maintenance parts available for your machine.

This chapter includes:

- [How to purchase](#)
- [Available supplies](#)
- [Replacing the toner cartridge](#)
- [Checking replaceable's lifespan](#)

 Available accessories may differ from country to country. Contact your sales representatives to obtain the list of available accessories.

How to purchase

To order Dell-authorized supplies and accessories visit www.dell.com/supplies, or contact your local Dell dealer or the retailer where you purchased your machine. You can also visit www.dell.com or support.dell.com, select your country/region, and obtain information on calling for service.

Available supplies

When supplies reach their lifespan, you can order the following types of supplies for your machine:

Type	Average yield ^[a]	Part number
Standard capacity toner cartridge	Approx. 1,500 pages	3J11D
High capacity toner cartridge	Approx. 2,500 pages	2MMJP

^[a] Declared yield value in accordance with ISO/IEC 19752.

To replace a toner cartridge see [Replacing the toner cartridge](#).

 Depending on the options and job mode used, the toner cartridge's lifespan may differ.

 You must purchase supplies, including toner cartridges, in the same country where you purchased your machine. Otherwise, it will be incompatible with your machine since the system configuration of these vary from country to country.

 Dell does not recommend using non-genuine Dell toner cartridge such as refilled or remanufactured toners. Dell cannot guarantee non-genuine Dell toner cartridge's quality. Service or repair required as a result of using non-genuine Dell toner cartridges will not be covered under the machine warranty.

Replacing the toner cartridge



When a toner cartridge has reached its estimated cartridge life:

- **End of life Replace new cart** message appears on the display.
- The machine stops printing. Incoming faxes are saved in memory.

At this stage, the toner cartridge needs to be replaced. Check the type of the toner cartridge for your machine (See [Available supplies](#)).

1. Open the front door.
2. Pull the toner cartridge out.

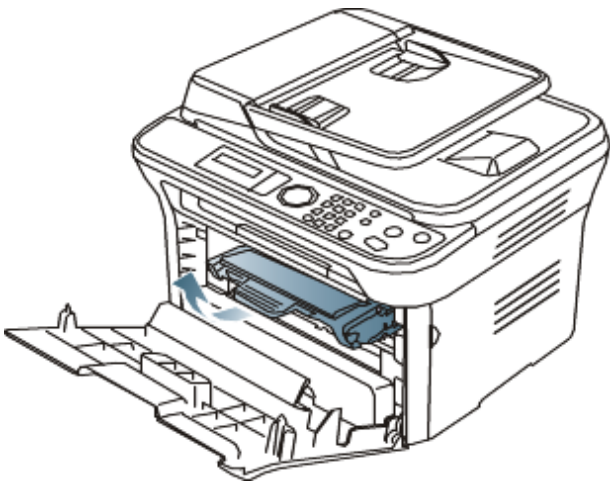

3. Take a new toner cartridge out of its package.
4. Remove the paper protecting the toner cartridge by pulling the packing tape.

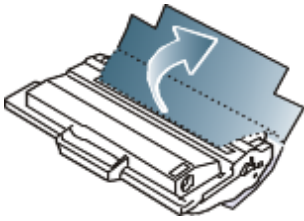

5. Locate the sealing tape at the end of the toner cartridge. Carefully pull the tape completely out of the cartridge and discard it.

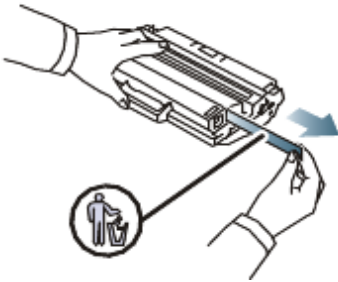

- The sealing tape should be longer than 60 cm (23.6 inches) when correctly removed.
- Holding the toner cartridge, pull the sealing tape straight to remove it from the cartridge. Be careful not to cut the tape. If this happens, you cannot use the toner cartridge.
- Refer to the pictures on the cartridge wrapping paper.

6. Slowly shake the cartridge five or six times to distribute the toner evenly inside the cartridge. It will assure maximum copies per cartridge.

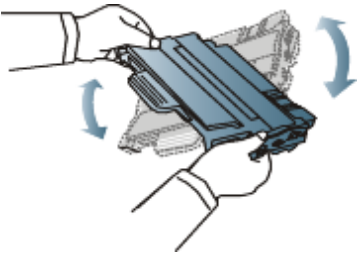

- If toner gets on your clothing, wipe it off with a dry cloth and wash clothing in cold water. Hot water sets toner into fabric.
- Do not touch the green underside of the toner cartridge. Use the handle on the cartridge to avoid touching this area.

7. Hold the toner cartridge by the handle and slowly insert the cartridge into the opening in the machine. Tabs on the sides of the cartridge and corresponding grooves within the machine will guide the cartridge into the correct position until it locks into place completely.

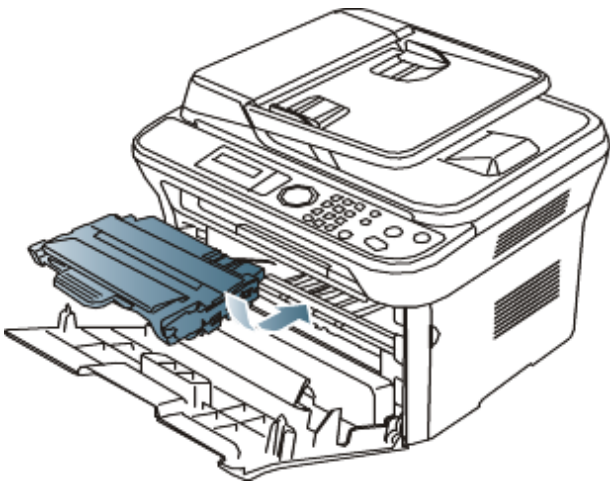

8. Close the front door. Make sure that the cover is securely closed.

Checking replaceable's lifespan

If you experience frequent paper jams or printing problems, check the number of pages the machine has printed. Replace the corresponding parts, if necessary.

1. Press **Menu** (☰) on the control panel.
2. Press the left/right arrow until **System Setup** appears and press **OK**.
3. Press the left/right arrow until **Maintenance** appears and press **OK**.
4. Press the left/right arrow until **Supplies Life** appears and press **OK**.
5. Press the left/right arrow until the item you want appears and press **OK**.
 - **Supplies Info**: Prints the supply information page.
 - **Total**: Displays the total number of pages printed.
 - **ADF Scan**: Displays the number of pages scanned using the ADF.
 - **Platen Scan**: Displays the number of pages scanned using the scanner glass.
6. Press **Stop/Clear** (⏹) to return to ready mode.

Troubleshooting

This chapter gives you different troubleshooting steps.

This chapter includes:

- [Redistributing toner](#)
- [Clearing original document jams](#)
- [Tips for avoiding paper curls](#)
- [Tips for avoiding paper jams](#)
- [Clearing paper jams](#)
- [Understanding display messages](#)
- [Solving other problems](#)

Redistributing toner

When the toner cartridge is near the end of its life:

- White streaks or light printing occurs.
- **Prepare new cartridge** appears on the display.
- The **Status** LED blinks red.

If this happens, you can temporarily improve print quality by redistributing the remaining toner in the cartridge. In some cases, white streaks or light printing will still occur even after you have redistributed the toner.

1. Open the front door.
2. Pull the toner cartridge out.

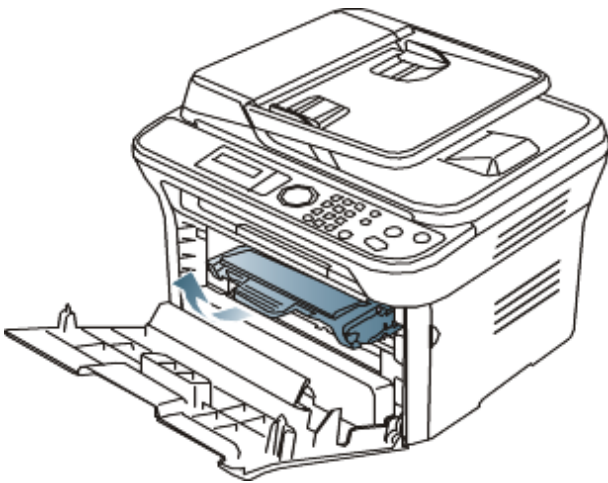

3. Thoroughly roll the cartridge five or six times to distribute the toner evenly inside the cartridge.

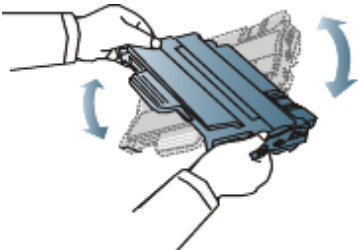

 If toner gets on your clothing, wipe it off with a dry cloth and wash clothing in cold water. Hot water sets toner into fabric.

 Do not touch the green underside of the toner cartridge. Use the handle on the cartridge to avoid touching this area.

4. Hold the toner cartridge by the handle and slowly insert the cartridge into the opening in the machine.

Tabs on the sides of the cartridge and corresponding grooves within the machine will guide the cartridge into the correct position until it locks into place completely.

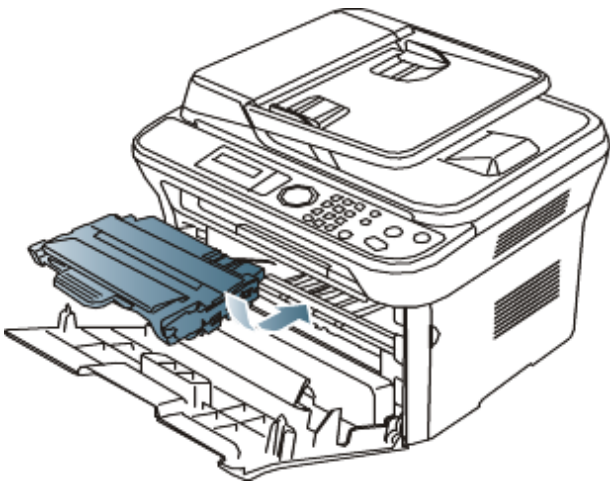

5. Close the front door. Ensure that the cover is securely closed.

Clearing original document jams

When an original jams while passing through the document feeder, a warning message appears on the display screen.

- ⚠ To avoid tearing the document, remove the jammed document slowly and gently.
- 📄 To prevent document jams, use the scanner glass for thick, thin, or mixed paper-type originals.
 1. Remove any remaining pages from the document feeder.
 2. Open the document feeder cover.

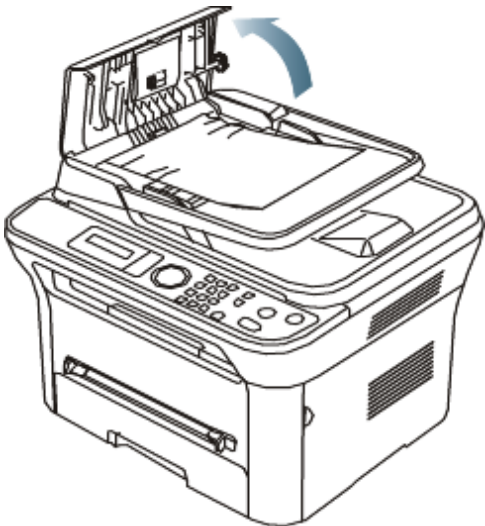

3. Gently remove the jammed paper from the document feeder.

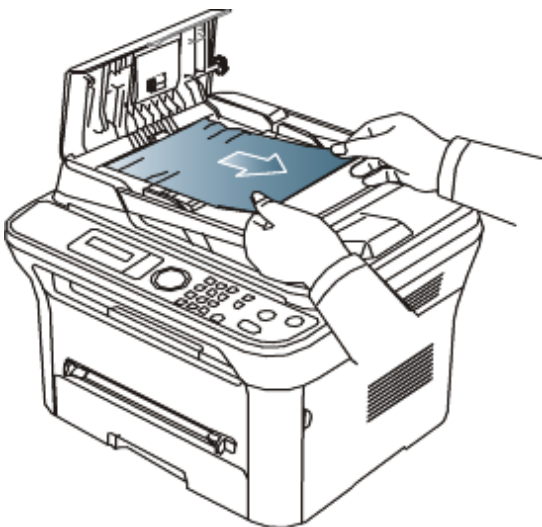

📄 If you see no paper in this area, go to step 5.

4. Close the document feeder cover. Reload the pages you removed, if any, in the document feeder.

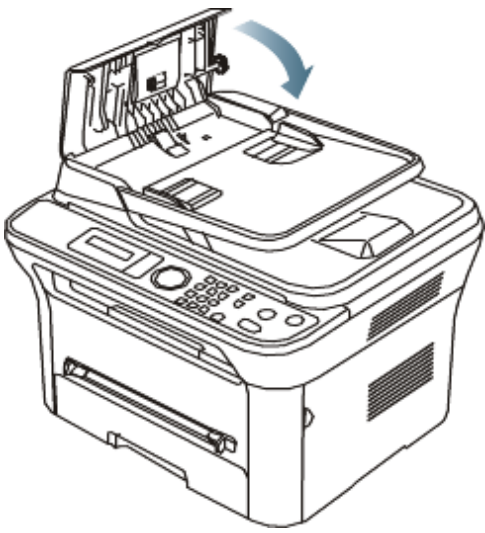

5. Open the scanner lid.
6. Seize the misfeed paper, and remove the paper from the feed area by carefully pulling it to the right using both hands.

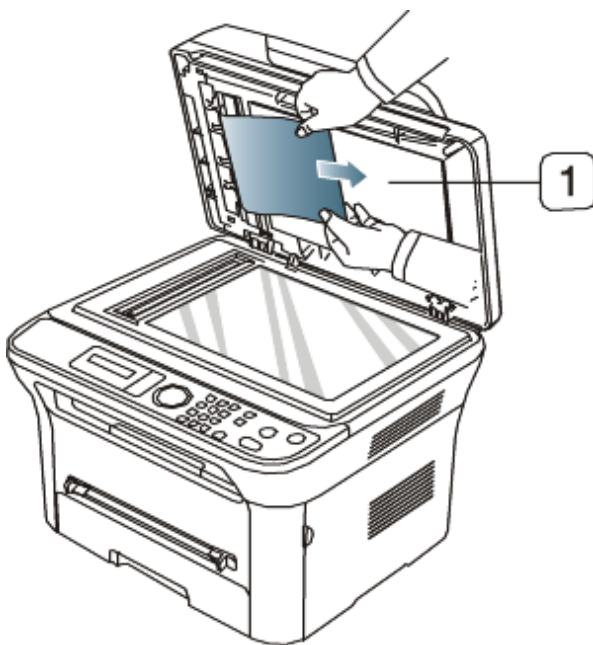

1. scanner lid

7. Close the scanner lid. Load the removed pages back into the document feeder.

Tips for avoiding paper curls

1. Open the rear door.
2. Pull down the pressure lever on each side.

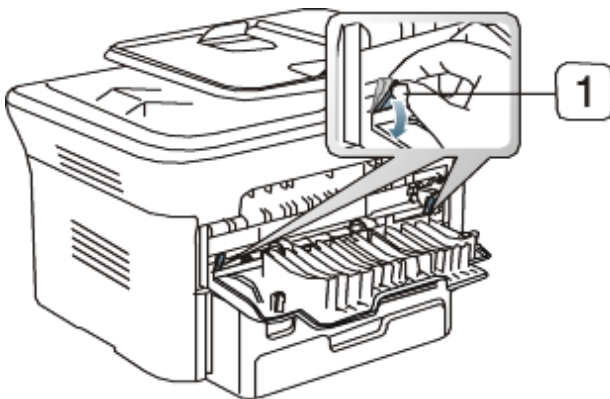

1. Pressure lever

- Keep the rear cover opened during printing.
Only use when the printout has more than 20 mm curl.



Tips for avoiding paper jams

By selecting the correct media types, most paper jams can be avoided. When a paper jam occurs, refer to the next guidelines.

- Ensure that the adjustable guides are positioned correctly (See [Loading paper in the tray](#)).
- Do not overload the tray. Ensure that the paper level is below the paper capacity mark on the inside of the tray.
- Do not remove paper from the tray while your machine is printing.
- Flex, fan, and straighten paper before loading.
- Do not use creased, damp, or highly curled paper.
- Do not mix paper types in a tray.
- Use only recommended print media (See [Setting the paper size and type](#)).
- Ensure that the recommended side of the print media is facing down in the tray, or facing up in the manual tray.

Clearing paper jams

When a paper jam occurs, a warning message appears on the display.

To resume printing after clearing paper jams, you must open and close the front door.

-  To avoid tearing the paper, pull the jammed paper out slowly and gently. Follow the instructions in the following sections to clear the jam.

In tray 1



1. Open and close the front door. The jammed paper is automatically ejected from the machine.
If the paper does not exit, go to the next step.
2. Pull out tray 1 .

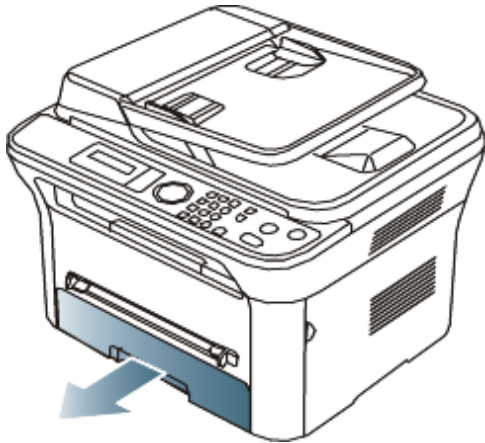

3. Remove the jammed paper by gently pulling it straight out.

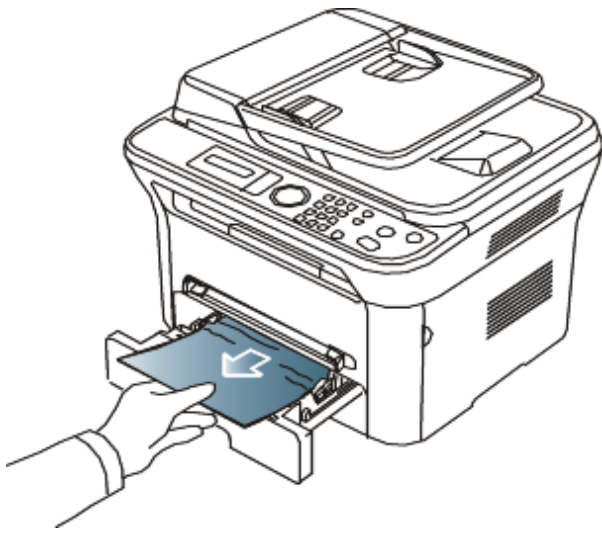

If the paper does not move when you pull, or if you do not see the paper in this area, check the fuser area around the toner cartridge (See [Inside the machine](#)).

4. Insert tray 1 back into the machine until it snaps into place. Printing automatically resumes.

In the manual tray



1. If the paper is not feeding properly, pull the paper out of the machine.

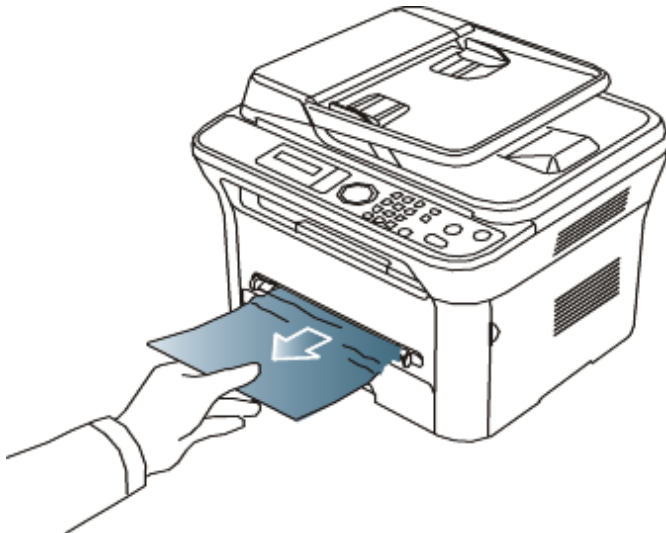

2. Open and close the front door to resume printing.

Inside the machine



The fuser area is hot. Take care when removing paper from the machine.

1. Open the front door and pull the toner cartridge out, lightly pushing it down.

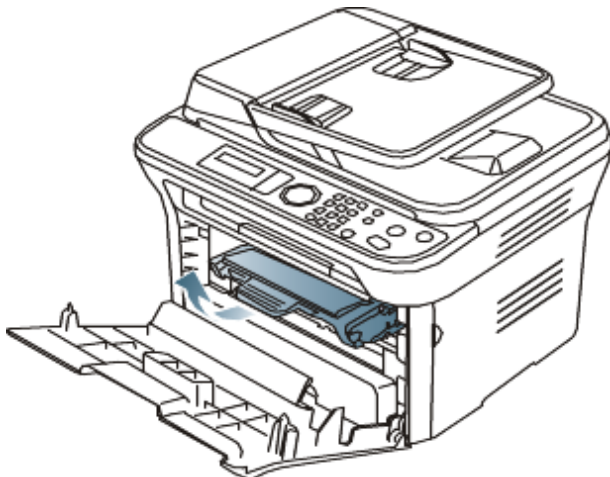

2. Remove the jammed paper by gently pulling it straight out.

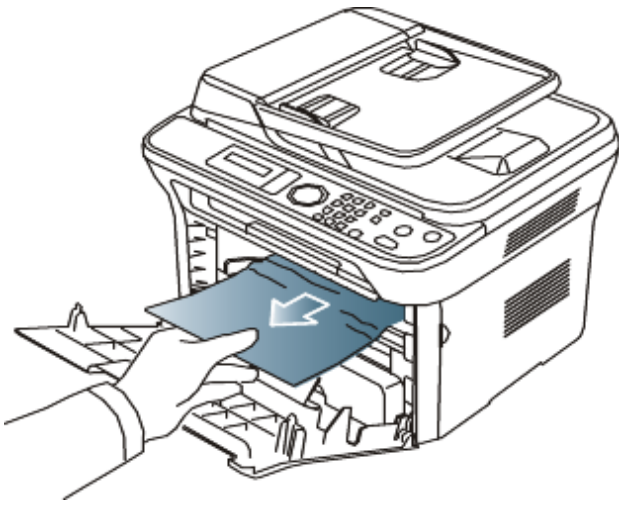

3. Replace the toner cartridge and close the front door. Printing automatically resumes.

In exit area



1. Open and close the front door. The jammed paper is automatically ejected from the machine. If you do not see the jammed paper, go to next step.
2. Gently pull the paper out of the output tray.

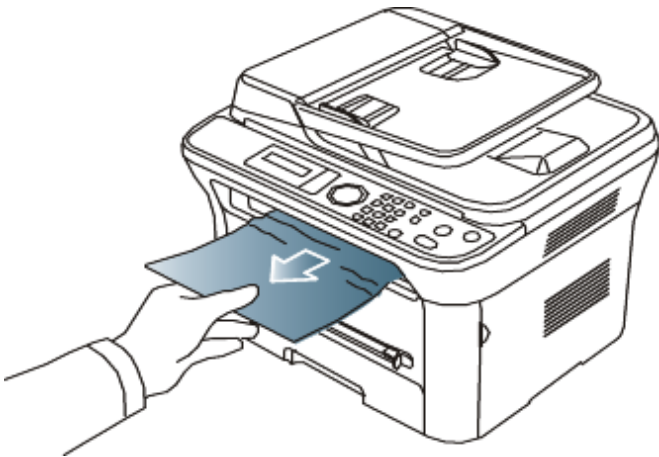

If you do not see the jammed paper or if there is any resistance when you pull, stop and go to the next step.

3. Open the rear door.
4. Pull the pressure levers down and remove the paper.

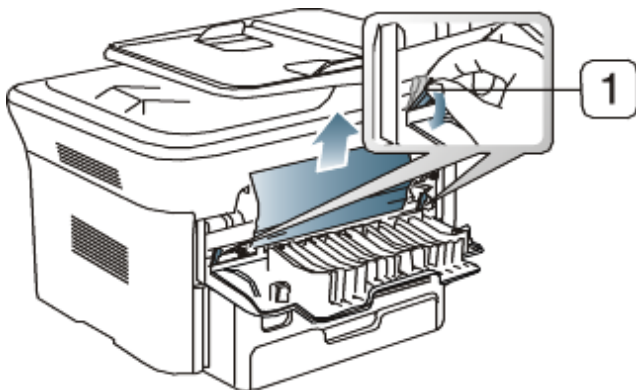

1. Pressure lever

If you do not see the jammed paper, go to next step.

5. Pull the fuser cover levers down and remove the paper. Return the fuser cover levers to their original position.

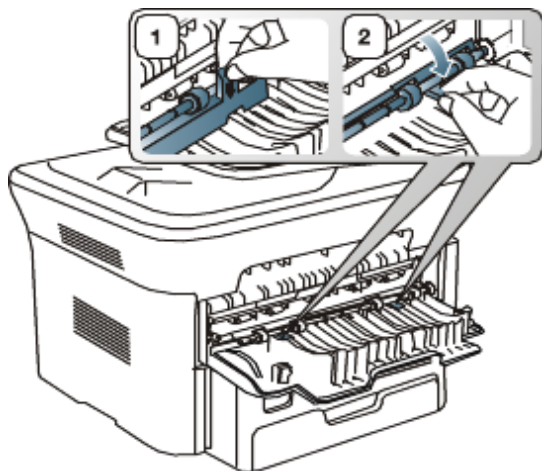

 The fuser area is hot. Take care when removing paper from the machine.

6. Return the pressure levers to their original position.
7. Close the rear door.
8. Open and close front door, printing automatically resumes.

Understanding display messages

Messages appear on the control panel display to indicate the machine's status or errors. Refer to the tables below to understand the messages' and their meaning, and correct the problem, if necessary.

Checking display messages

-  • If a message is not in the table, reboot the power and try the printing job again. If the problem persists, call for service.
- When you call for service, provide the service representative with the contents of display message.
- Some messages may not appear in the display depending on the options or models.
- [error number] indicates the error number.
- [tray type] indicates the tray number.
- [media type] indicates the media type.
- [media size] indicates the media size.
- [color] indicates the color of toner or imaging unit.

Message	Meaning	Suggested solutions
[COMM. Error]	The machine has a communication problem.	Ask the sender to try again.
[Incompatible]	The machine has received a fax from which is registered as a junk fax.	The received fax data will be deleted. Reconfirm junk fax setup. See page 50
[Line Busy]	The receiving fax machine did not answer or the line is already engaged.	Try again after a few minutes.
[Line Error]	Your machine cannot connect with the receiving fax machine or has lost contact because of a problem with the phone line.	Try again. If the problem persists, wait an hour or so for the line to clear and try again. Or, turn the ECM mode on. See page 50.
[Stop Pressed]	Stop/Clear has been pressed during an operation.	Try again.
BOOTP problemAuto IP Run	The IP address assignment is failed. This happens, when Auto IP for BOOTP is set in Embedded Web Service.	Change the IP address assignment method to DHCP or Static. If you do not change this option, the BOOTP server continually asks to assign the IP Address.
BOOTP problemReconfigure DHCP	The IP address assignment is failed. This happens, when Auto IP for BOOTP is not set in Embedded Web Service.	Change the IP address assignment method to DHCP or Static. If you do not change this option, the BOOTP server continually asks to assign the IP Address.
DHCP problem: Auto IP Run	The IP address assignment is failed. This happens, when Auto IP for DHCP is set in Embedded Web Service.	Change the IP address assignment method to BOOTP or Static. If you do not change this option, the DHCP server continually asks to assign the IP Address.

DHCP problemReconfigure BOOTP	The IP address assignment is failed. This happens, when Auto IP for DHCP is not set in Embedded Web Service.	Change the IP address assignment method to BOOTP or Static. If you do not change this option, the DHCP server continually asks to assign the IP Address.
Document Jam. Remove Jam	The loaded original has jammed in the ADF.	Clear the jam (See Clearing original document jams).
Door Open. Close it	The front cover is not securely latched.	Close the cover until it locks into place.
End of lifeReplace new cart	<p>The indicated toner cartridge has reached its estimated cartridge life. The printer stops printing.</p> <p> Estimated cartridge life means the expected or estimated toner cartridge life, which indicates the average capacity of print-outs and is designed pursuant to ISO/IEC 19752 (See Available supplies). The number of pages may be affected by operating environment, printing interval, media type, and media size. Some amount of toner may remain in the cartridge even when End of life Replace new cart appears and the printer stops printing.</p>	Replace the toner cartridge (See Replacing the toner cartridge).
Error [error number] Turn off then on	A systematic error has occurred	Reboot the power and try the printing job again. If the problem persists, call for service.
Install Toner	The toner cartridge is installed improperly, or not installed.	Reinstall the toner cartridge two or three times to confirm it is seated properly. If the problem persists, the toner cartridge is not being detected. Contact the service representatives.
Load [media size] in [tray number]	There is no corresponding paper in the corresponding tray.	Load corresponding paper in the corresponding tray (See Loading paper in the tray).
Memory Full Remove Job	The memory is full.	Press the left/right arrow to highlight Cancel or Start , then press OK . If you select Cancel , the machine stops the fax job. If you select Start , the machine only sends scanned documents of the fax job.
Network Problem: IP Conflict	The IP address is used elsewhere.	Check the IP address or obtain a new IP address.
No Answer	The receiving fax machine has not answered after several redial attempts.	Try again. Make sure that the receiving machine is operational.
Not Compatible toner cartridge	The toner cartridge is not suitable for your machine.	Install the corresponding toner cartridge with a Dell-genuine cartridge (See Replacing the toner cartridge).
Output bin Full Remove paper	The output tray is full. Or the sensor is not facing down.	Remove papers from the output tray, the machine resumes printing. Or make sure the sensor is facing down. If the problem persists, call for service.
Paper Empty in [tray number]	There is no paper in the indicated tray.	Load paper in the tray (See Loading paper in the tray).
Pulled Out [tray number] Cassette	The indicated tray cassette is not inserted, or not properly closed.	To close the tray, lower the rear edge, align it with the slot, and slide it into the printer.
Paper Jam in MP Tray	Paper has jammed in the manual tray area.	Clear the jam (See In the manual tray).
Paper Jam in Tray 1	Paper has jammed in the tray1 area.	Clear the jam (See In tray 1).
Paper Jam inside machine	Paper has jammed inside the machine.	Clear the jam (See Inside the machine).

Paper Jam in exit area	Special print media has jammed in the paper exit area.	Clear the jam. <ul style="list-style-type: none"> • See In exit area. • See In the manual tray)
Prepare new cartridge	Small amount of toner is left in the indicated cartridge. The estimated cartridge life of toner is close.	Prepare a new cartridge for a replacement. You may temporarily increase the printing quality by redistributing the toner (See Redistributing toner).
Remove seal tape & Install Toner	The machine cannot detect a toner cartridge.	Remove the sealing tape from the toner cartridge. Refer to Quick Install Guide.
Replace Toner	The toner cartridge has almost reached its estimated cartridge life.	You can choose between Stop or Continue as shown on the control panel. If you select Stop , the printer stops printing and you cannot print any more without changing the cartridge. If you select Continue , the printer keeps printing but the printing quality cannot be guaranteed. Replace the toner cartridge for the best print quality when this message appears. Using a cartridge beyond this stage can result in printing quality issues (See Replacing the toner cartridge).  Dell does not recommend using non-genuine Dell toner cartridge such as refilled or remanufactured. Dell cannot guarantee non-genuine Dell toner cartridge's quality. Service or repair required as a result of using non-genuine Dell toner cartridges will not be covered under the machine warranty.
Replace new Fuser unit	The life of the fuser unit has expired.	Replace the fuser unit with a new one. Contact the service representatives.
Self Diagnostics Please wait	The engine in your printer is checking some problems detected.	Please wait a few minutes.
Too many Faxes Remove Job	Too many faxes are received.	Remove received fax.

Solving other problems

The following chart lists some conditions that may occur and the recommended solutions. Follow the suggested solutions until the problem is corrected. If the problem persists, call for service.

Other problems include:

- See [System problems](#).
- See [Power problems](#).
- See [Paper feeding problems](#).
- See [Printing problems](#).
- See [Printing quality problems](#).
- See [Copying problems](#).
- See [Scanning problems](#).
- See [Fax problems](#).
- See [Dell Scan and Fax Manager Problem](#).
- See [Common Windows problems](#).
- See [Common Linux problems](#).
- See [Common Macintosh problems](#).



System problems

Condition	Suggested solutions
The red error light is on.	Turn the machine on/off. If the problem persists, contact a service representative (See Contacting Dell ”).

 The machine is experiencing problems that require service such as LSU error or fuser error.

Power problems

 [Click this link to open an animation about solving power problems.](#)

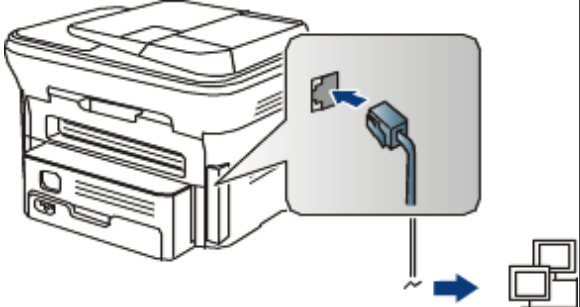
Condition	Suggested solutions
<p>The machine is not receiving power, or the connection cable between the computer and the machine is not connected properly.</p>	<ul style="list-style-type: none"> • Plug in the power cord and press Power () on the control panel. <div data-bbox="1058 398 1390 696" style="text-align: center;">  </div> • Disconnect the machine cable and reconnect it. <ul style="list-style-type: none"> ◦ For Local Printing <div data-bbox="979 792 1506 1043" style="text-align: center;">  </div> ◦ For Network Printing (network model only) <div data-bbox="954 1099 1536 1404" style="text-align: center;">  </div>

Paper feeding problems

Condition	Suggested solutions
Paper jams during printing.	Clear the paper jam (See Clearing paper jams).
Paper sticks together.	<ul style="list-style-type: none"> • Check the maximum paper capacity of the tray (See Print media specifications). • Make sure that you are using the correct type of paper (See Print media specifications). • Remove paper from the tray and flex or fan the paper. • Humid conditions may cause some paper to stick together.
Multiple sheets of paper do not feed.	Different types of paper may be stacked in the tray. Load paper of only one type, size, and weight.
Paper does not feed into the machine.	<ul style="list-style-type: none"> • Remove any obstructions from inside the machine. • Paper has not been loaded correctly. Remove paper from the tray and reload it correctly. • There is too much paper in the tray. Remove excess paper from the tray. • The paper is too thick. Use only paper that meets the specifications required by the machine (See Print media specifications). • If an original does not feed into the machine, the document feeder rubber pad may

	require to be replaced. Contact a service representative.
The paper keeps jamming.	<ul style="list-style-type: none"> • There is too much paper in the tray. Remove excess paper from the tray. If you are printing on special materials, use the manual tray. • An incorrect type of paper is being used. Use only paper that meets the specifications required by the machine (See Print media specifications). • There may be debris inside the machine. Open the front door and remove any debris. • If an original does not feed into the machine, the document feeder rubber pad may need to be replaced. Contact a service representative.
Transparencies stick together in the paper exit.	Use only transparencies specifically designed for laser printers. Remove each transparency as it exits from the machine.
Envelopes skew or fail to feed correctly.	Ensure that the paper guides are against both sides of the envelopes.

Printing problems

Condition	Possible cause	Suggested solutions
The machine does not print.	The machine is not receiving power.	Check the power cord connections.
	The machine is not selected as the default machine.	Select your machine as your default machine in your Windows.
	Check the machine for the following: <ul style="list-style-type: none"> • The front door is not closed. Close the front door. • Paper is jammed. Clear the paper jam (See Clearing paper jams). • No paper is loaded. Load paper (See Loading paper in the tray). • The toner cartridge is not installed. Install the toner cartridge. If a system error occurs, contact your service representative.	
	The connection cable between the computer and the machine is not connected properly.	Disconnect the machine cable and reconnect it.
	The connection cable between the computer and the machine is defective.	If possible, attach the cable to another computer that is working properly and print a job. You can also try using a different cable.
	The port setting is incorrect.	Check the Windows printer setting to make sure that the print job is sent to the correct port. If the computer has more than one port, make sure that the machine is attached to the correct one.
	The machine may be configured incorrectly.	Check the Printing Preferences to ensure that all of the print settings are correct (See Opening printing preferences).
	The printer driver may be incorrectly installed.	Repair the machine software (See Installing USB connected machine's driver , Installing network connected machine's driver).
The machine does not print.	The machine is malfunctioning.	Check the display message on the control panel to see if the machine is indicating a system error. Contact a service representative.
	The document size is so big that the hard disk space of the computer is insufficient to access the print job.	Get more hard disk space and print the document again.
The machine does not print.	The output tray is full.	Once the paper is removed from the output tray, the machine resumes printing.
	The machine selects print materials from the wrong paper source.	For many software applications, the paper source selection is found under the Paper tab within the Printing Preferences . Select the correct paper source. See the printer driver help screen (See Opening printing preferences).
A print job is extremely	The job may be very	Reduce the complexity of the page or try adjusting the print

slow.	complex.	quality settings.
Half the page is blank.	The page orientation setting may be incorrect.	Change the page orientation in your application. See the printer driver help screen.
	The paper size and the paper size settings do not match.	Ensure that the paper size in the printer driver settings matches the paper in the tray.Or, ensure that the paper size in the printer driver settings matches the paper selection in the software application settings you use.
The machine prints, but the text is wrong, garbled, or incomplete.	The machine cable is loose or defective.	Disconnect the machine cable and reconnect. Try a print job that you have already printed successfully. If possible, attach the cable and the machine to another computer that you know works and try a print job. Finally, try a new machine cable.
	The wrong printer driver was selected.	Check the application's printer selection menu to ensure that your machine is selected.
	The software application is malfunctioning.	Try printing a job from another application.
	The operating system is malfunctioning.	Exit Windows and reboot the computer. Turn the machine off and back on again.
Pages print, but they are blank.	The toner cartridge is defective or out of toner.	Redistribute the toner, if necessary. If necessary, replace the toner cartridge.
	The file may have blank pages.	Check the file to ensure that it does not contain blank pages.
	Some parts, such as the controller or the board, may be defective.	Contact a service representative.
The machine does not print PDF file correctly. Some parts of graphics, text, or illustrations are missing.	Incompatibility between the PDF file and the Acrobat products.	Printing the PDF file as an image may enable the file to print. Turn on Print As Image from the Acrobat printing options.  It will take longer to print when you print a PDF file as an image.
The print quality of photos is not good. Images are not clear.	The resolution of the photo is very low.	Reduce the photo size. If you increase the photo size in the software application, the resolution will be reduced.
Before printing, the machine emits vapor near the output tray.	Using damp paper can cause vapor during printing.	This is not a problem. Just keep printing.
The machine does not print special- sized paper, such as billing paper.	Paper size and paper size setting do not match.	Set the correct paper size in the Custom Paper Size Settings in the Paper tab in the Printing Preferences (See Opening printing preferences).

Printing quality problems

If the inside of the machine is dirty or paper has been loaded improperly, there might be a reduction in print quality. See the table below to clear the problem.

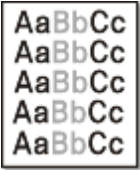
Condition	Suggested Solutions
Light or faded print 	<ul style="list-style-type: none"> If a vertical white streak or faded area appears on the page, the toner supply is low. You may be able to temporarily extend the toner cartridge life (See Redistributing toner). If this does not improve the print quality, install a new toner cartridge. The paper may not meet paper specifications; for example, the paper may be too moist or rough (See Print media specifications). If the entire page is light, the print resolution setting is too low or the toner save mode is on. Adjust the print resolution and turn the toner save mode off. See the help screen of the printer driver. A combination of faded or smeared defects may indicate that the toner cartridge needs cleaning (See Cleaning the inside). The surface of the LSU part inside the machine may be dirty (See Cleaning the inside).
Toner specks	<ul style="list-style-type: none"> The paper may not meet specifications; for example, the paper may be too moist or rough (See Print media specifications).

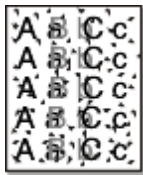

- The transfer roller may be dirty. Clean the inside of your machine. Contact a service representative.
- The paper path may need cleaning. Contact a service representative.

Dropouts

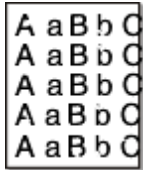

If faded areas, generally rounded, occur randomly on the page:

- A single sheet of paper may be defective. Try reprinting the job.
- The moisture content of the paper is uneven or the paper has moist spots on its surface. Try a different brand of paper (See [Print media specifications](#)).
- The paper lot is bad. The manufacturing processes can cause some areas to reject toner. Try a different kind or brand of paper.
- Change the printer option and try again. Go to **Printing Preferences**, click **Paper** tab, and set type to **Thick** (See [Opening printing preferences](#)).
- If these steps do not correct the problem, contact a service representative.

White Spots



If white spots appear on the page:

- The paper is too rough and a lot of dirt from a paper falls to the inner devices within the machine, so the transfer roller may be dirty. Clean the inside of your machine (See [Cleaning the inside](#)).
- The paper path may need cleaning (See [Cleaning the inside](#)).

Vertical lines

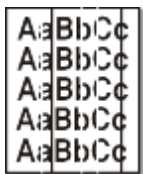

If black vertical streaks appear on the page:

- The surface (drum part) of the toner cartridge inside the machine has probably been scratched. Remove the toner cartridge and install a new one (See [Replacing the toner cartridge](#)).

If white vertical streaks appear on the page:

- The surface of the LSU part inside the machine may be dirty (See [Cleaning the inside](#)).

Black background



If the amount of background shading becomes unacceptable:

- Change to a lighter weight paper (See [Print media specifications](#)).
- Check the environmental conditions: very dry conditions or a high level of humidity (higher than 80% RH) can increase the amount of background shading.
- Remove the old toner cartridge and, install a new one (See [Replacing the toner cartridge](#)).

Toner smear

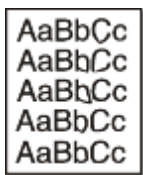

If toner smears on the page:

- Clean the inside of the machine (See [Cleaning the inside](#)).
- Check the paper type and quality (See [Print media specifications](#)).
- Remove the toner cartridge and then, install a new one (See [Replacing the toner cartridge](#)).

Vertical repetitive defects



If marks repeatedly appear on the printed side of the page at even intervals:



- The toner cartridge may be damaged. If you still have the same problem, remove the toner cartridge and, install a new one (See [Replacing the toner cartridge](#)).
- Parts of the machine may have toner on them. If the defects occur on the back of the page, the problem will likely correct itself after a few more pages.
- The fusing assembly may be damaged. Contact a service representative.



Background scatter

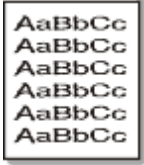
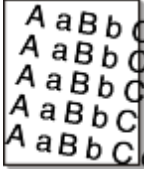
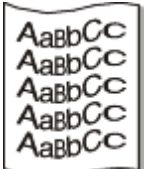
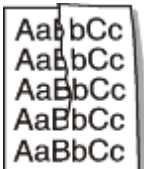
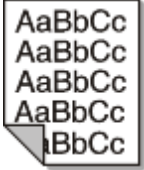
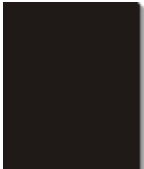
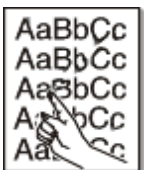

Background scatter results from bits of toner randomly distributed on the printed page.

- The paper may be too damp. Try printing with a different batch of paper. Do not open packages of paper until necessary so that the paper does not absorb too much moisture.
- If background scatter occurs on an envelope, change the printing layout to avoid printing over areas that have overlapping seams on the reverse side. Printing on seams can cause problems.

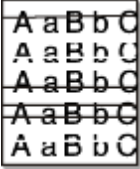
	<ul style="list-style-type: none"> If background scatter covers the entire surface area of a printed page, adjust the print resolution through your software application or in Printing Preferences (See Opening printing preferences).
<p>Misformed characters</p> 	<ul style="list-style-type: none"> If characters are improperly formed and producing hollow images, the paper stock may be too slick. Try different paper (See Print media specifications). If characters are improperly formed and producing a wavy effect, the scanner unit may need service (See Cleaning the scan unit).
<p>Page skew</p> 	<ul style="list-style-type: none"> Ensure that the paper is loaded properly. Check the paper type and quality (See Print media specifications). Ensure that the guides are not too tight or too loose against the paper stack.
<p>Curl or wave</p> 	<ul style="list-style-type: none"> Ensure that the paper is loaded properly. Check the paper type and quality. Both high temperature and humidity can cause paper curl (See Print media specifications). Turn the stack of paper over in the tray. Also try rotating the paper 180° in the tray.
<p>Wrinkles or creases</p> 	<ul style="list-style-type: none"> Ensure that the paper is loaded properly. Check the paper type and quality (See Print media specifications). Turn the stack of paper over in the tray. Also try rotating the paper 180° in the tray.
<p>Back of printouts are dirty</p> 	<p>Check for leaking toner. Clean the inside of the machine (See Cleaning the inside).</p>
<p>Solid Color or Black pages</p> 	<ul style="list-style-type: none"> The toner cartridge may not be installed properly. Remove the cartridge and reinsert it. The toner cartridge may be defective. Remove the toner cartridge and install a new one (See Replacing the toner cartridge). The machine may require repair. Contact a service representative.
<p>Loose toner</p> 	<ul style="list-style-type: none"> Clean the inside of the machine (See Cleaning the inside). Check the paper type and quality (See Print media specifications). Remove the toner cartridge and then, install a new one (See Replacing the toner cartridge). If the problem persists, the machine may require repair. Contact a service representative.
<p>Character Voids</p> 	<p>Character voids are white areas within parts of characters that should be solid black:</p> <ul style="list-style-type: none"> If you are using transparencies, try another type of transparency. Because of the composition of transparencies, some character voids are normal. You may be printing on the wrong surface of the paper. Remove the paper and turn it around. The paper may not meet paper specifications (See Print media specifications).
<p>Horizontal stripes</p>	<p>If horizontally aligned black streaks or smears appear:</p> <ul style="list-style-type: none"> The toner cartridge may be installed improperly. Remove the cartridge and

	<p>reinsert it.</p> <ul style="list-style-type: none"> The toner cartridge may be defective. Remove the toner cartridge and install a new one (See Replacing the toner cartridge). If the problem persists, the machine may require repair. Contact a service representative.
<p>Curl</p> 	<p>If the printed paper is curled or paper does not feed into the machine:</p> <ul style="list-style-type: none"> Turn the stack of paper over in the tray. Also try rotating the paper 180° in the tray. Change the printer option and try again. Go to Printing Preferences, click Paper tab, and set type to Thin (See Opening printing preferences).
<p>An unknown image repetitively appears on a few sheets or loose toner, light print, or contamination occurs.</p>	<p>Your machine is probably being used at an altitude of 1,000 m (3,281 ft.) or above. The high altitude may affect the print quality, such as loose toner or light imaging. Change the correct altitude setting to your machine (See Altitude adjustment).</p>

Copying problems

Condition	Suggested solution
Copies are too light or too dark.	Use Darkness in Copy feature to lighten or darken the backgrounds of copies (See Changing the darkness).
<p>Smears, lines, marks, or spots appear on copies.</p> 	<ul style="list-style-type: none"> If the defects are on the original, use Darkness in Copy feature to lighten the background of your copies (See Changing the darkness). If there are no defects on the original, clean the scan unit (See Cleaning the scan unit).
Copy image is skewed.	<ul style="list-style-type: none"> Ensure that the original is face down on the scanner glass or face up in the document feeder. Check that the copy paper is loaded correctly.
Blank copies print out.	Ensure that the original is face down on the scanner glass or face up in the document feeder.
Image rubs off the copy easily.	<ul style="list-style-type: none"> Replace the paper in the tray with paper from a new package. In high humidity areas, do not leave paper in the machine for extended periods of time.
Frequent copy paper jams occur.	<ul style="list-style-type: none"> Fan the stack of paper, then turn it over in the tray. Replace the paper in the tray with a fresh supply. Check/adjust the paper guides, if necessary. Ensure that the paper is the proper paper weight. Check for copy paper or pieces of copy paper remaining in the machine after a paper jam has been cleared.
Toner cartridge produces fewer copies than expected before running out of toner.	<ul style="list-style-type: none"> Your originals may contain pictures, solids, or heavy lines. For example, your originals may be forms, newsletters, books, or other documents that use more toner. The scanner lid may be left open while copies are being made. Turn the machine off and back on.

Scanning problems

Condition	Suggested solutions
The scanner does not work.	<ul style="list-style-type: none"> Make sure that you place the original to be scanned face down on the scanner glass, or face up in the document feeder. There may not be enough available memory to hold the document you want to scan. Try the Prescan function to see if that works. Try lowering the scan resolution rate. Check that the machine cable is connected properly.

	<p>Make sure that the machine cable is not defective. Switch the cable with a known good cable. If necessary, replace the cable.</p> <ul style="list-style-type: none"> • Check that the scanner is configured correctly. Check scan setting in the SmarThru or the application you want to use to make certain that the scanner job is being sent to the correct port (for example, USB001).
The unit scans very slowly.	<ul style="list-style-type: none"> • Check if the machine is printing received data. If so, scan the document after the received data has been printed. • Graphics are scanned more slowly than text. • Communication speed slows in scan mode because of the large amount of memory required to analyze and reproduce the scanned image. Set your computer to the ECP printer mode through BIOS setting. It will help to increase the speed. For details about how to set BIOS, refer to your computer user's guide.
<p>Message appears on your computer screen:</p> <ul style="list-style-type: none"> • Device can't be set to the H/W mode you want. • Port is being used by another program. • Port is Disabled. • Scanner is busy receiving or printing data. When the current job is completed., try again. • Invalid handle. • Scanning has failed. 	<ul style="list-style-type: none"> • There may be a copying or printing job in progress. Try your job again when that job is finished. • The selected port is currently being used. Restart your computer and try again. • The machine cable may be improperly connected or the power may be off. • The scanner driver is not installed or the operating environment is not set up properly. • Ensure that the machine is properly connected and the power is on, then restart your computer. • The USB cable may be improperly connected or the power may be off.

Fax problems

condition	suggested solutions
The machine is not working, there is no display, or the buttons are not working.	<ul style="list-style-type: none"> • Unplug the power cord and plug it in again. • Ensure that there is power being supplied to the electrical outlet.
No dial tone.	<ul style="list-style-type: none"> • Check that the phone line is properly connected. • Check that the phone socket on the wall is working by plugging in another phone.
The numbers stored in memory do not dial correctly.	Make sure that the numbers are stored in memory correctly. Print an Address Book list (See Setting up address book).
The original does not feed into the machine.	<ul style="list-style-type: none"> • Make sure that the paper is not wrinkled and you are inserting it in correctly. Check that the original is the right size, not too thick or thin. • Make sure that the document feeder is firmly closed. • The document feeder rubber pad may need to be replaced. Contact a service representative.
Faxes are not received automatically.	<ul style="list-style-type: none"> • The receiving mode should be set to fax. • Make sure that there is paper in the tray. • Check to see if the display shows any error message. If it does, clear the problem.
The machine does not send.	<ul style="list-style-type: none"> • Make sure that the original is loaded in the document feeder or on the scanner glass. • Check the fax machine you are sending to, to see if it can receive your fax.
The incoming fax has blank spaces or is of poor-quality.	<ul style="list-style-type: none"> • The fax machine sending you the fax may be faulty. • A noisy phone line can cause line errors. • Check your machine by making a copy. • A toner cartridge has reached its estimated cartridge life. Replace the toner cartridge (See Replacing the toner cartridge).

Some of the words on an incoming fax are stretched.	The fax machine sending the fax had a temporary document jam.
There are lines on the originals you sent.	Check your scan unit for marks and clean it (See Cleaning the scan unit).
The machine dials a number, but the connection with the other fax machine fails.	The other fax machine may be turned off, out of paper, or cannot answer incoming calls. Speak with the other machine operator and ask her/him to solve out the problem.
Faxes do not store in memory.	There may not be enough memory space to store the fax. If the display indicating the memory status shows, delete any faxes you no longer need from the memory, and then try to store the fax again. Call for service.
Blank areas appear at the bottom of each page or on other pages, with a small strip of text at the top	You may have chosen the wrong paper settings in the user option setting. For details about paper settings, see Setting the paper size and type .

Dell Scan and Fax Manager Problem

Condition	suggested solution
Dell Scan and Fax Manager does not work.	Check your system requirements. Dell Scan and Fax Manager works in Windows (See System requirements).

Common Windows problems

Condition	Suggested solutions
"File in Use" message appears during installation.	Exit all software applications. Remove all software from the printer's startup group, then restart Windows. Reinstall the printer driver.
"General Protection Fault", "Exception OE", "Spool 32", or "Illegal Operation" messages appear.	Close all other applications, reboot Windows and try printing again.
"Fail To Print", "A printer timeout error occurred" messages appear.	These messages may appear during printing. Just keep waiting until the machine finishes printing. If the message appears in standby mode or after printing has been completed, check the connection and/or whether an error has occurred.

 Refer to Microsoft Windows User's Guide that came with your computer for further information on Windows error messages.

Common Linux problems

condition	Suggested solutions
The machine does not print.	<ul style="list-style-type: none"> • Check if the printer driver is installed in your system. Open Unified Driver Configurator and switch to the Printers tab in Printers configuration window to look at the list of available machines. Make sure that your machine is displayed on the list. If not, open Add new printer wizard to set up your device. • Check if the machine is started. Open Printers configuration and select your machine on the printers list. Look at the description in the Selected printer pane. If its status contains Stopped string, press the Start button. After that normal operation of the machine should be restored. The "stopped" status might be activated when some problems in printing occurred. For instance, this could be an attempt to print a document when the port is claimed by a scanning application. • Ensure the port is not busy. Since functional components of machine (printer and scanner) share the same I/O interface (port), the situation of simultaneous access of different user applications to the same port is possible. To avoid possible conflicts, only one of them at a time is allowed to gain control over the device. The other user will encounter "device busy" response. You should open ports configuration and select the port assigned to your machine. In the Selected port pane you can see if the port is occupied by some other application. If this is the case, you should either wait for completion of the current job or press the Release port button, if you are sure that the present application is not functioning properly. • Check if your application has special print option such as "-oraw". If "-oraw" is specified in the command line parameter, then remove it to print properly. For Gimp front-end, select "print" -> "Setup printer" and edit command line parameter in the command item. • The CUPS (Common Unix Printing System) version distributed with SuSE Linux 9.2 (cups-1.1.21) has a problem with IPP (Internet Printing Protocol) printing. Use the socket printing instead of ipp or install a later version of CUPS (cups-1.1.22 or higher).

The machine does not print whole pages, and output is printed on half the page.	It is a known problem that occurs when a color machine is used on version 8.51 or earlier of Ghostscript, 64-bit Linux OS, and has been reported to bugs.ghostscript.com as Ghostscript Bug 688252. The problem is solved in AFPL Ghostscript v. 8.52 or above. Download the latest version of AFPL Ghostscript from http://sourceforge.net/projects/ghostscript/ and install it to solve this problem.
I cannot scan via Gimp Front-end.	Check if Gimp Front-end has Xsane: Device dialog . on the Acquire menu. If not, you should install Xsane plug-in for Gimp on your computer. You can find Xsane plug-in package for Gimp on Linux distribution CD or Gimp home page. For the detailed information, refer to the Help for Linux distribution CD or Gimp Front-end application. If you wish to use another kind of scan application, refer to application's Help.
I encounter error "Cannot open port device file" when printing a document.	Avoid changing print job parameters (via LPR GUI, for example) while a print job is in progress. Known versions of CUPS server break the print job whenever print options are changed and then try to restart the job from the beginning. Since Unified Linux Driver locks the port while printing, the abrupt termination of the driver keeps the port locked and unavailable for subsequent print jobs. If this situation occurs, try to release the port by selecting Release port in Port configuration window.
The machine does not appear on the scanners list.	<ul style="list-style-type: none"> • Ensure your machine is attached to your computer, connected properly via the USB port, and is turned on. • Ensure the scanner driver for your machine is installed in your system. Open Unified Linux Driver configurator, switch to Scanners configuration, then press Drivers. Make sure that driver with a name corresponding to your machine's name is listed in the window. • Ensure the port is not busy. Since functional components of machine (printer and scanner) share the same I/O interface (port), the situation of simultaneous access of different user applications to the same port is possible. To avoid possible conflicts, only one of them at a time is allowed to gain control over the device. The other user will encounter "device busy" response. This usually happens when starting a scan procedure. An appropriate message box appears. <p>To identify the source of the problem, open the Ports configuration and select the port assigned to your scanner, port's symbol /dev/mfp0 corresponds to LP:0 designation displayed in the scanners' options, /dev/mfp1 relates to LP:1, and so on. USB ports start at /dev/mfp4, so scanner on USB:0 relates to /dev/mfp4 respectively and so forth sequentially. In the Selected port pane, you can see if the port is occupied by another application. If this is the case, you should either wait for completion of the current job or press the Release port button, if you are sure that the present port application is not functioning properly.</p>
The machine does not scan.	<ul style="list-style-type: none"> • Ensure a document is loaded into the machine, ensure your machine is connected to the computer. • If there is an I/O error while scanning.

 Refer to Linux User's Guide that came with your computer for further information on Linux error messages.

Common Macintosh problems

condition	Suggested solutions
The machine does not print PDF files correctly. Some parts of graphics, text, or illustrations are missing.	Printing the PDF file as an image may enable the file to print. Turn on Print As Image from the Acrobat printing options.  It will take longer to print when you print a PDF file as an image.
The document has printed, but the print job has not disappeared from the spooler in Mac OS X 10.3.2.	Update your Mac OS to Mac OS X 10.3.3. or higher.
Some letters are not displayed normally during the cover page printing.	Mac OS cannot create the font during the cover page printing. The English alphabet and numbers are displayed normally on the cover page.
When printing a document in Mac OS with Acrobat Reader 6.0 or higher, colors print	Make sure that the resolution setting in your machine driver matches the one in Acrobat Reader.

incorrectly.

-  Refer to Macintosh User's Guide that came with your computer for further information on Macintosh error messages.

Appendix

Dell technical support policy

Technician-assisted technical support requires the cooperation and participation of the customer in the troubleshooting process and provides for restoration of the Operating System, application software, and hardware drivers to the original default configuration as shipped from Dell, as well as the verification of appropriate functionality of the printer and all Dell-installed hardware. In addition to this technician assisted technical support, online technical support is available at Dell Support. Additional technical support options may be available for purchase.

Dell provides limited technical support for the printer and any Dell-installed software and peripherals. Support for third-party software and peripherals is provided by the original manufacturer, including those purchased and/or installed through Software & Peripherals (DellWare), ReadyWare, and Custom Factory Integration (CFI/DellPlus).

Contacting Dell

You can access Dell Support at support.dell.com. Select your region on the WELCOME TO DELL SUPPORT page, and fill in the requested details to access help tools and information.

You can contact Dell electronically using the following addresses:

- World Wide Web

www.dell.com/

www.dell.com/ap/ (Asian/Pacific countries only)

www.dell.com/jp/ (Japan only)

www.euro.dell.com (Europe only)

www.dell.com/la/ (Latin American and Caribbean countries)

www.dell.ca (Canada only)

- Anonymous file transfer protocol (FTP)

ftp.dell.com

Log in as user: anonymous, and use your email address as your password.

- Electronic Support Service

mobile_support@us.dell.com

support@us.dell.com

la-techsupport@dell.com (Latin America and Caribbean countries only)

apsupport@dell.com (Asian/Pacific countries only)

support.jp.dell.com (Japan only)

support.euro.dell.com (Europe only)

- Electronic Quote Service

apmarketing@dell.com (Asian/Pacific countries only)

sales_canada@dell.com (Canada only)

Warranty and return policy

Dell Inc. ("Dell") manufactures its hardware products from parts and components that are new or equivalent to new in accordance with industry-standard practices. For information about the Dell warranty for your printer, refer to the Product Information Guide.

Glossary

 The following glossary helps you get familiar with the product by understanding the terminologies commonly used with printing as well as mentioned in this user's guide.

802.11

802.11 is a set of standards for wireless local area network (WLAN) communication, developed by the IEEE LAN/MAN Standards Committee (IEEE 802).

802.11b/g

802.11b/g can share the same hardware and use the 2.4 GHz band. 802.11b supports bandwidth up to 11 Mbps; 802.11g up to 54 Mbps. 802.11b/g devices may occasionally suffer interference from microwave ovens, cordless telephones, and Bluetooth devices.

Access point

Access Point or Wireless Access Point (AP or WAP) is a device that connects wireless communication devices together on wireless local area networks (WLAN), and acts as a central transmitter and receiver of WLAN radio signals.

ADF

An Automatic Document Feeder (ADF) is a mechanism that will automatically feed an original sheet of paper so that the machine can scan some amount of the paper at once.

AppleTalk

AppleTalk is a proprietary suite of protocols developed by Apple, Inc for computer networking. It was included in the original Macintosh (1984) and is now deprecated by Apple in favor of TCP/IP networking.

BIT Depth

A computer graphics term describing the number of bits used to represent the color of a single pixel in a bitmapped image. Higher color depth gives a broader range of distinct colors. As the number of bits increases, the number of possible colors becomes impractically large for a color map. 1-bit color is commonly called as monochrome or black and white.

BMP

A bitmapped graphics format used internally by the Microsoft Windows graphics subsystem (GDI), and used commonly as a simple graphics file format on that platform.

BOOTP

Bootstrap Protocol. A network protocol used by a network client to obtain its IP address automatically. This is usually done in the bootstrap process of computers or operating systems running on them. The BOOTP servers assign the IP address from a pool of addresses to each client. BOOTP enables 'diskless workstation' computers to obtain an IP address prior to loading any advanced operating system.

CCD

Charge Coupled Device (CCD) is a hardware which enables the scan job. CCD Locking mechanism is also used to hold the CCD module to prevent any damage when you move the machine.

Collation

Collation is a process of printing a multiple-copy job in sets. When collation is selected, the device prints an entire set before printing additional copies.

Control Panel

A control panel is a flat, typically vertical, area where control or monitoring instruments are displayed. They are typically found in front of the machine.

Coverage

It is the printing term used for a toner usage measurement on printing. For example, 5% coverage means that an A4 sided paper has about 5% image or text on it. So, if the paper or original has complicated images or lots of text on it, the coverage will be higher and at the same time, a toner usage will be as much as the coverage.

CSV

Comma Separated Values (CSV). A type of file format, CSV is used to exchange data between disparate applications. The file format, as it is used in Microsoft Excel, has become a pseudo standard throughout the industry, even among non-Microsoft platforms.

DADF

A Duplex Automatic Document Feeder (DADF) is a mechanism that will automatically feed and flip over an original sheet of paper so that the machine can scan on both sides of the paper.

Default

The value or setting that is in effect when taking a printer out of its box state, reset, or initialized.

DHCP

A Dynamic Host Configuration Protocol (DHCP) is a client-server networking protocol. A DHCP server provides configuration parameters specific to the DHCP client host requesting, generally, information required by the client host to participate on an IP network. DHCP also provides a mechanism for allocation of IP addresses to client hosts.

DIMM

Dual Inline Memory Module (DIMM), a small circuit board that holds memory. DIMM stores all the data within the machine like printing data, received fax data.

DNS

The Domain Name Server (DNS) is a system that stores information associated with domain names in a distributed database on networks, such as the Internet.

Dot Matrix Printer

A dot matrix printer refers to a type of computer printer with a print head that runs back and forth on the page and prints by impact, striking an ink-soaked cloth ribbon against the paper, much like a typewriter.

DPI

Dots Per Inch (DPI) is a measurement of resolution that is used for scanning and printing. Generally, higher DPI results in a higher resolution, more visible detail in the image, and a larger file size.

DRPD

Distinctive Ring Pattern Detection. Distinctive Ring is a telephone company service which enables a user to use a single telephone line to answer several different telephone numbers.

Duplex

A mechanism that will automatically flip over a sheet of paper so that the machine can print (or scan) on both sides of the paper. A printer equipped with a Duplex can print double-sided of paper.

Duty Cycle

Duty cycle is the page quantity which does not affect printer performance for a month. Generally the printer has the lifespan limitation such as pages per year. The lifespan means the average capacity of print-outs, usually within the warranty period. For example, if the duty cycle is 48,000 pages per month assuming 20 working days, a printer limits 2,400 pages a day.

ECM

Error Correction Mode (ECM) is an optional transmission mode built into Class 1 fax machines or fax modems. It automatically detects and corrects errors in the fax transmission process that are sometimes caused by telephone line noise.

Emulation

Emulation is a technique of one machine obtaining the same results as another.

An emulator duplicates the functions of one system with a different system, so that the second system behaves like the first system. Emulation focuses on exact reproduction of external behavior, which is in contrast to simulation, which concerns an abstract model of the system being simulated, often considering its internal state.

Ethernet

Ethernet is a frame-based computer networking technology for local area networks (LANs). It defines wiring and signaling for the physical layer, and frame formats and protocols for the media access control (MAC)/data link layer of the OSI model. Ethernet is mostly standardized as IEEE 802.3. It has become the most widespread LAN technology in use.

EtherTalk

A suite of protocols developed by Apple Computer for computer networking. It was included in the original Macintosh (1984) and is now deprecated by Apple in favor of TCP/IP networking.

FDI

Foreign Device Interface (FDI) is a card installed inside the machine to allow a third party device such as a coin operated device or a card reader, those devices allow enabling the pay-for-print service on your machine.

FTP

A File Transfer Protocol (FTP) is a commonly used protocol for exchanging files over any network that supports the TCP/IP protocol (such as the Internet or an intranet).

Fuser Unit

The part of a laser printer that melts the toner onto the print media. It consists of a hot roller and a back-up roller. After toner is transferred onto the paper, the fuser unit applies heat and pressure to ensure that the toner stays on the paper permanently, which is why paper is warm when it comes out of a laser printer.

Gateway

A connection between computer networks, or between a computer network and a telephone line. It is very popular, as it is a computer or a network that allows access to another computer or network.

Grayscale

Shades of gray that represent light and dark portions of an image when color images are converted to grayscale; colors are represented by various shades of gray.

Halftone

An image type that simulates grayscale by varying the number of dots. Highly colored areas consist of a large number of dots, while lighter areas consist of a smaller number of dots.

HDD

Hard Disk Drive (HDD), commonly referred to as a hard drive or hard disk, is a non-volatile storage device which stores digitally-encoded data on rapidly rotating platters with magnetic surfaces.

IEEE

The Institute of Electrical and Electronics Engineers (IEEE) is an international non-profit, professional organization for the advancement of technology related to electricity.

IEEE 1284

The 1284 parallel port standard was developed by the Institute of Electrical and Electronics Engineers (IEEE). The term "1284-B" refers to a specific connector type on the end of the parallel cable that attaches to the peripheral (for example, a printer).

Intranet

A private network that uses Internet Protocols, network connectivity, and possibly the public telecommunication

system to securely share part of an organization's information or operations with its employees. Sometimes the term refers only to the most visible service, the internal website.

IP address

An Internet Protocol (IP) address is a unique number that devices use in order to identify and communicate with each other on a network utilizing the Internet Protocol standard.

IPM

The Images Per Minute (IPM) is a way of measuring the speed of a printer. An IPM rate indicates the number of single-sided sheets a printer can complete within one minute.

IPP

The Internet Printing Protocol (IPP) defines a standard protocol for printing as well as managing print jobs, media size, resolution, and so forth. IPP can be used locally or over the Internet to hundreds of printers, and also supports access control, authentication, and encryption, making it a much more capable and secure printing solution than older ones.

IPX/SPX

IPX/SPX stands for Internet Packet Exchange/Sequenced Packet Exchange. It is a networking protocol used by the Novell NetWare operating systems. IPX and SPX both provide connection services similar to TCP/IP, with the IPX protocol having similarities to IP, and SPX having similarities to TCP. IPX/SPX was primarily designed for local area networks (LANs), and is a very efficient protocol for this purpose (typically its performance exceeds that of TCP/IP on a LAN).

ISO

The International Organization for Standardization (ISO) is an international standard-setting body composed of representatives from national standards bodies. It produces world-wide industrial and commercial standards.

ITU-T

The International Telecommunication Union is an international organization established to standardize and regulate international radio and telecommunications. Its main tasks include standardization, allocation of the radio spectrum, and organizing interconnection arrangements between different countries to allow international phone calls. A -T out of ITU-T indicates telecommunication.

ITU-T No. 1 chart

Standardized test chart published by ITU-T for document facsimile transmissions.

JBIG

Joint Bi-level Image Experts Group (JBIG) is an image compression standard with no loss of accuracy or quality, which was designed for compression of binary images, particularly for faxes, but can also be used on other images.

JPEG

Joint Photographic Experts Group (JPEG) is a most commonly used standard method of lossy compression for photographic images. It is the format used for storing and transmitting photographs on the World Wide Web.

LDAP

The Lightweight Directory Access Protocol (LDAP) is a networking protocol for querying and modifying directory services running over TCP/IP.

LED

A Light-Emitting Diode (LED) is a semiconductor device that indicates the status of a machine.

MAC address

Media Access Control (MAC) address is a unique identifier associated with a network adapter. MAC address is a unique 48-bit identifier usually written as 12 hexadecimal characters grouped in pairs (e. g., 00-00-0c-34-11-4e). This address is usually hard-coded into a Network Interface Card (NIC) by its manufacturer, and used as an aid for routers trying to locate machines on large networks.

MFP

Multi Function Peripheral (MFP) is an office machine that includes the following functionality in one physical body, so as to have a printer, a copier, a fax, a scanner and etc.

MH

Modified Huffman (MH) is a compression method for decreasing the amount of data that needs to be transmitted between the fax machines to transfer the image recommended by ITU-T T.4. MH is a codebook-based run-length encoding scheme optimized to efficiently compress white space. As most faxes consist mostly of white space, this minimizes the transmission time of most faxes.

MMR

Modified Modified READ (MMR) is a compression method recommended by ITU-T T.6.

Modem

A device that modulates a carrier signal to encode digital information, and also demodulates such a carrier signal to decode transmitted information.

MR

Modified Read (MR) is a compression method recommended by ITU-T T.4. MR encodes the first scanned line using MH. The next line is compared to the first, the differences determined, and then the differences are encoded and transmitted.

NetWare

A network operating system developed by Novell, Inc. It initially used cooperative multitasking to run various services on a PC, and the network protocols were based on the archetypal Xerox XNS stack. Today NetWare supports TCP/IP as well as IPX/SPX.

OPC

Organic Photo Conductor (OPC) is a mechanism that makes a virtual image for print using a laser beam emitted from a laser printer, and it is usually green or gray colored and a cylinder shaped.

An exposing unit of a drum is slowly worn away by its usage of the printer, and it should be replaced appropriately since it gets scratches from grits of a paper.

Originals

The first example of something, such as a document, photograph or text, etc, which is copied, reproduced or translated to produce others, but which is not itself copied or derived from something else.

OSI

Open Systems Interconnection (OSI) is a model developed by the International Organization for Standardization (ISO) for communications. OSI offers a standard, modular approach to network design that divides the required set of complex functions into manageable, self-contained, functional layers. The layers are, from top to bottom, Application, Presentation, Session, Transport, Network, Data Link and Physical.

PABX

A private automatic branch exchange (PABX) is an automatic telephone switching system within a private enterprise.

PCL

Printer Command Language (PCL) is a Page Description Language (PDL) developed by HP as a printer protocol and has become an industry standard. Originally developed for early inkjet printers, PCL has been released in varying levels for thermal, matrix printer, and page printers.

PDF

Portable Document Format (PDF) is a proprietary file format developed by Adobe Systems for representing two dimensional documents in a device independent and resolution independent format.

PostScript

PostScript (PS) is a page description language and programming language used primarily in the electronic and desktop publishing areas. - that is run in an interpreter to generate an image.

Printer Driver

A program used to send commands and transfer data from the computer to the printer.

Print Media

The media like paper, envelopes, labels, and transparencies which can be used on a printer, a scanner, a fax or, a copier.

PPM

Pages Per Minute (PPM) is a method of measurement for determining how fast a printer works, i.e. the number of pages a printer can produce in one minute.

PRN file

An interface for a device driver, this allows software to interact with the device driver using standard input/output system calls, simplifying many tasks.

Protocol

A convention or standard that controls or enables the connection, communication, and data transfer between two computing endpoints.

PS

See PostScript.

PSTN

The Public-Switched Telephone Network (PSTN) is the network of the world's public circuit-switched telephone networks which, on industrial premises, is usually routed through the switchboard.

RADIUS

Remote Authentication Dial In User Service (RADIUS) is a protocol for remote user authentication and accounting. RADIUS enables centralized management of authentication data such as usernames and passwords using an AAA (authentication, authorization, and accounting) concept to manage network access.

Resolution

The sharpness of an image, measured in Dots Per Inch (DPI). The higher the dpi, the greater the resolution.

SMB

Server Message Block (SMB) is a network protocol mainly applied to share files, printers, serial ports, and miscellaneous communications between nodes on a network. It also provides an authenticated Inter-process communication mechanism.

SMTP

Simple Mail Transfer Protocol (SMTP) is the standard for e-mail transmissions across the Internet. SMTP is a relatively simple, text-based protocol, where one or more recipients of a message are specified, and then the message text is transferred. It is a client-server protocol, where the client transmits an email message to the server.

SSID

Service Set Identifier (SSID) is a name of a wireless local area network (WLAN). All wireless devices in a WLAN use the same SSID in order to communicate with each other. The SSIDs are case-sensitive and have a maximum length of 32 characters.

Subnet Mask

The subnet mask is used in conjunction with the network address to determine which part of the address is the

network address and which part is the host address.

TCP/IP

The Transmission Control Protocol (TCP) and the Internet Protocol (IP); the set of communications protocols that implement the protocol stack on which the Internet and most commercial networks run.

TCR

Transmission Confirmation Report (TCR) provides details of each transmission such as job status, transmission result and number of pages sent. This report can be set to print after each job or only after failed transmissions.

TIFF

Tagged Image File Format (TIFF) is a variable-resolution bitmapped image format. TIFF describes image data that typically come from scanners. TIFF images make use of tags, keywords defining the characteristics of the image that is included in the file. This flexible and platform-independent format can be used for pictures that have been made by various image processing applications.

Toner Cartridge

A container for the toner.

Toner

Toner is a powder used in laser printers and photocopiers, which forms the text and images on the printed paper. Toner can be melted by the heat of the fuser, causing it to bind to the fibers in the paper.

TWAIN

An industry standard for scanners and scanner software. By using a TWAIN-compliant scanner with a TWAIN-compliant software program, a scan can be initiated from within the program.; an image capture API for Microsoft Windows and Apple Macintosh operating systems.

UNC Path

Uniform Naming Convention (UNC) is a standard way to access network shares in Windows NT and other Microsoft products. The format of a UNC path is: \\<servername>\<sharename>\<Additional directory>

URL

Uniform Resource Locator (URL) is the global address of documents and resources on the Internet. The first part of the address indicates what protocol to use, the second part specifies the IP address or the domain name where the resource is located.

USB

Universal Serial Bus (USB) is a standard that was developed by the USB Implementers Forum, Inc. to connect computers and peripherals. Unlike the parallel port, USB is designed to concurrently connect a single computer USB port to multiple peripherals.

Watermark

A watermark is a recognizable background image or pattern that is lighter than the printed text.

WEP

Wired Equivalent Privacy (WEP) is a security protocol specified in IEEE 802.11 to provide the same level of security as that of a wired LAN. WEP provides security by encrypting data over radio so that it is protected as it is transmitted from one end point to another.

WIA

Windows Imaging Architecture (WIA) is an imaging architecture that was originally introduced in Windows XP. A scan can be initiated from within these operating systems by using a WIA-compliant scanner.

WPA

Wi-Fi Protected Access (WPA) is a class of systems to secure wireless (Wi-Fi) computer networks, which was created to improve upon the security features of WEP.

WPA-PSK

WPA-PSK (WPA Pre-Shared Key) is special mode of WPA for small business or home users. A shared key, or password, is configured in the wireless access point (WAP) and any wireless laptop or desktop devices. WPA-PSK generates a unique key for each session between a wireless client and the associated WAP for more advanced security.